

ENTECH

DENTAL CATALOGUE

Dental Instrument
Manufacturer & Trade Deposit Co.
H-4031 Debrecen Ond Str. 1/b.

Factory:
H-4002 Debrecen
Balmazújvárosi Str. 10.

Tel.: 0036 52/538-300

Tel./Fax: 0036 52/538-301

E-mail: dentech@dentech.hu

www.dentech.hu



FOGSZONDÁK -

ZAHNSONDEN - EXPLORERS



.../HG

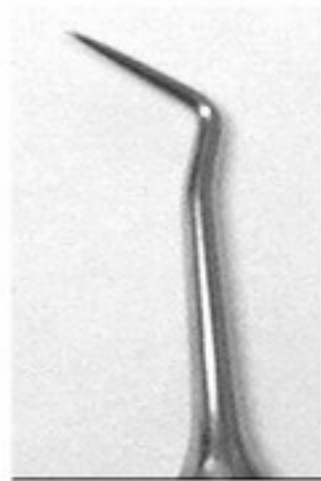

DA 1409



DA 1402

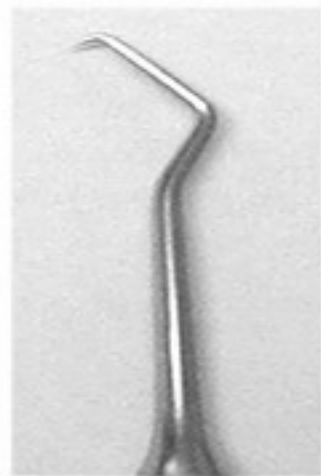

DA 1412



DA 1406

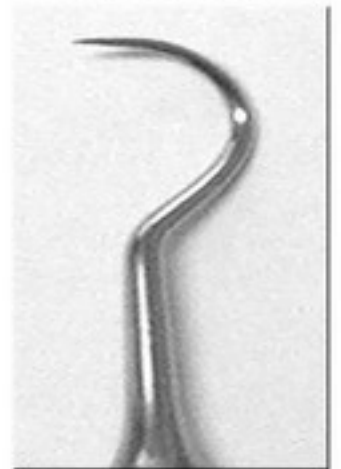

DA 1418

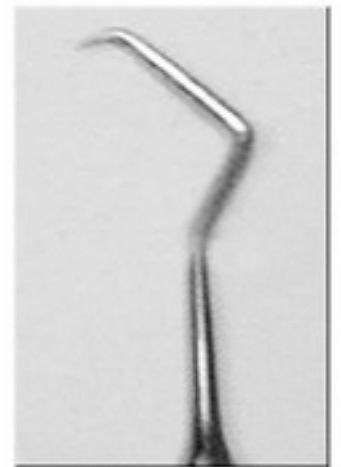

DA1414

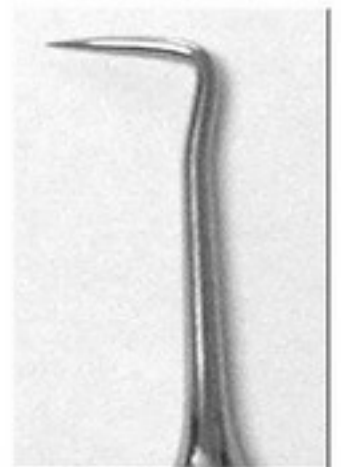

DA1408

FOGTÜKÖR - MUNDSPIEGEL - MOUTH MIRROR



DA 181 DA 180

FOGTÜKÖRNYÉL
MUNDSPIEGELGRIFF
MIRROR HANDLE
13.5cm

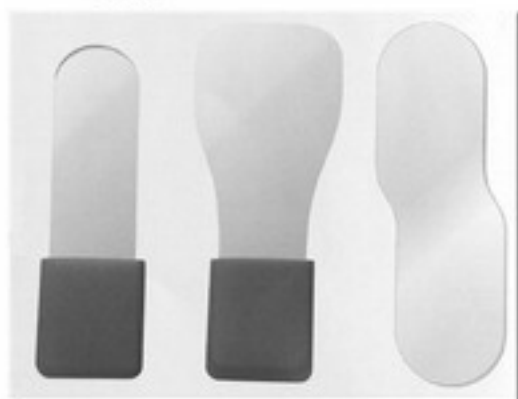

DA 140 DA 141 DA 142

INTRAORÁLIS TÜKÖR
INTRAORAL-SPIEGEL
INTRAORAL MIRROR



SÍK -
PLAN -
PLANE

DA 125



DOMBORÚ-
HOHL-
MAGNIFYING

DA 135

 ϕ 24 mm

DA 136 KREUTER

KETTŐS TÜKÖR, FÉM
DOPPELSPIEGEL METALL ROSTFREI
DOUBLE MIRROR STAINLESS STEEL

 ϕ 24 mm

DA 137

RHÓDIUM TÜKÖR, SÍK
MUNDSPIEGEL RHODIUM, PLAN
MOUTHMIRROR RHODIUM, PLANE



DA 138

RHÓDIUM TÜKÖR DUPLA
MUNDSPIEGEL RHODIUM DOPELTE
MOUTHMIRROR RHODIUM DOUBLE



DA 139

FRONT TÜKÖR
MUNDSPIEGEL FRONT
MOUTHMIRROR, FRONT



DB 1768

DB 1769

WHO

DB 1766
TASAKMÉRŐ SZONDA
PARODONTOMETER
PERIODONTOMETER



SZIKENYÉL
SKALPELL GRIF
SCALPEL HANDLE

BB 173

PENGMÉRÉT 6-16
FÜR KLINGEN 6-16
BLADES 6-16

BB 184

PENGMÉRÉT 18-36
FÜR KLINGEN 18-36
BLADES 18-36

KENDŐCSIPESZ
TUCHKLEMME
TOWEL CLAMPS

Schaedel
8,7 cm

BF 1411



KENDŐFOGÓ
TUCHKLEMME
TOWEL CLAMPS

Backhaus
11 cm

BF 1432

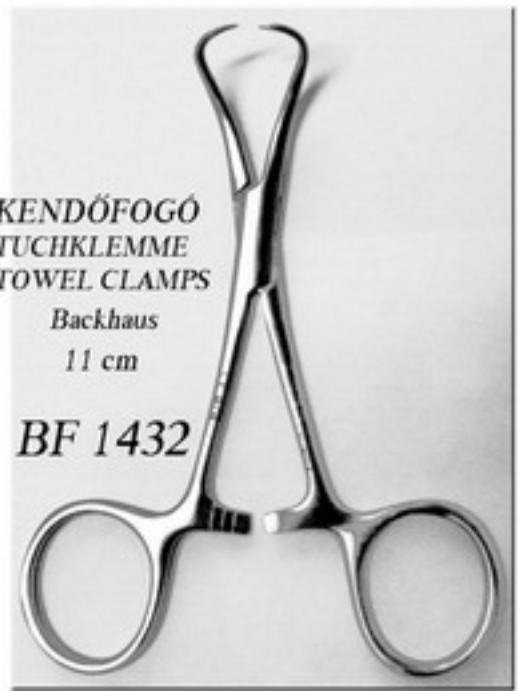

FOGÁSZATI CSIPESZEK - ZAHNPINZETTEN - TWEEZERS 16 cm

DA 1221



DA 1225



DA 1251



DA 1257



DA 1210



DA 1212



DA 1271

ZÁRAS FOGCSIPESZ - ZAHNPINZETTE
MIT SCHLOB - TOOTH TWEEZERS
WITH LOCH

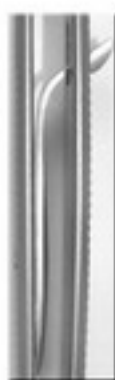

DA 1290

GYÖKÉRCAPSIPESZ - ZAHNWURZELPINZETTEN
PIN HOLDING TWEEZERS



DA 1291

ARTIKULÁCIÓS PAPIRCSIPESZ - ARTIKULATIONSPIPER-PINZETTEN
FORCEPS FOR ARTICULATING PAPER



DR 1780

FOGÁSZATI CSIPESZEK - ZAHNPINZETTEN - TWEEZERS 15 cm



DA 2220



DA 2221



DA 2225



DA 2251



HORGAS CSIPESZEK FINOM-
FEINE HAKENPINZETTE -
DELICATE TISSUE FORCEPS

BD 1669

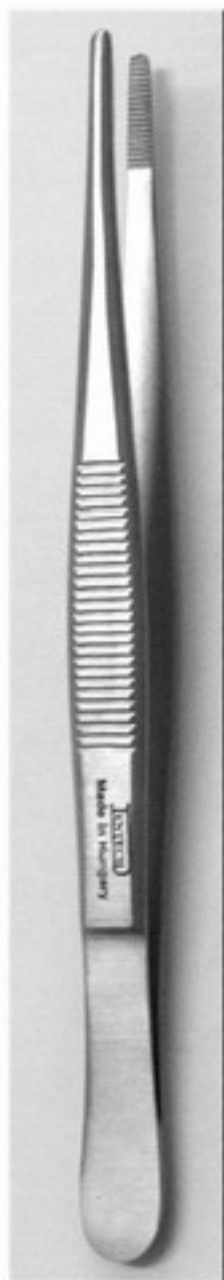

BD 1670

ANATÓMIAI CSIPESZEK -
ANATOMISCHE PINZETTE -
DRESSING AND DISSECTING FORCEPS

BD 143	11.5 cm
BD 145	13 cm
BD 147	14.5 cm
BD 149	16 cm
BD 150	18 cm
BD 151	20 cm
BD 152	25 cm
BD 153	30 cm

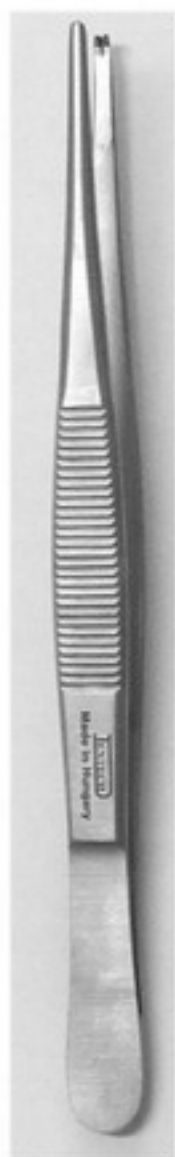

BD 1553	11.5cm
BD 1555	13 cm
BD 1557	14.5 cm
BD1559	16 cm

BD 1000

11 cm

**SZÁLKACSIPESZ
SPLITTERPINZETTE
SPLINTER FORCEPS**
HORGAS CSIPESZEK -
HAKENPINZETTE -
TISSUE FORCEPS

1x2



DB 1939

ORBÁN PARADONTÁLIS KÉS

ORBÁN GINGIVECTOMY MESSER

ORBÁN GINGIVECTOMIEMESSER

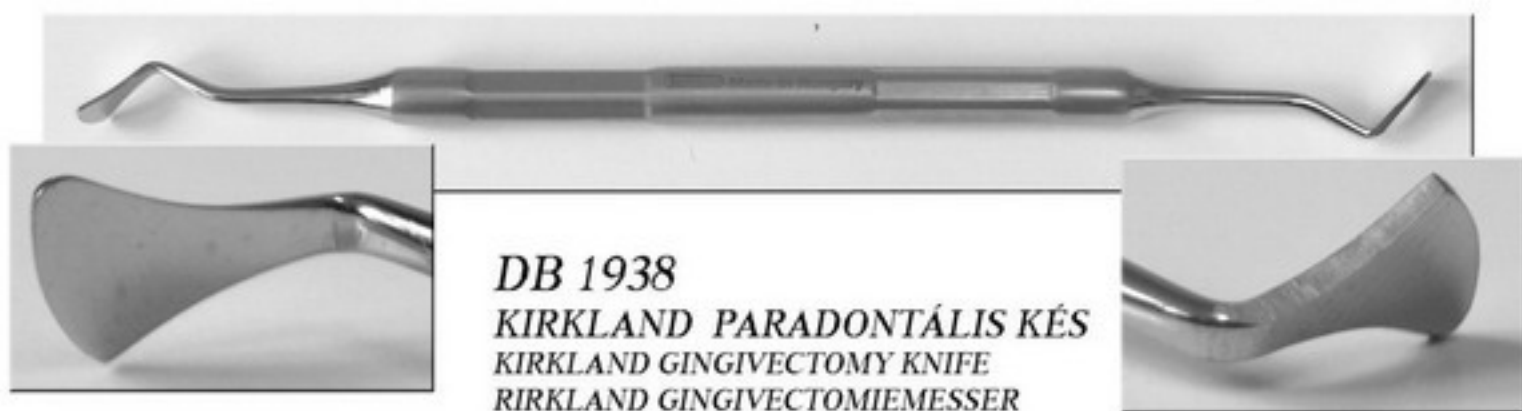

DB 1938

KIRKLAND PARADONTÁLIS KÉS

KIRKLAND GINGIVECTOMY KNIFE

KIRKLAND GINGIVECTOMIEMESSER

FOGÁSZATI KÜRETTEK "GRACEY" - ZAHNKÜRETTEN "GRACEY" - GRACEY CURETTES



DB 1700

DB 1701

DB 1702

DB 1703

DB 1704

DB 1705

DB 1706

Fig. 1/2

Fig. 3/4

Fig. 5/6

Fig. 7/8

Fig. 9/10

Fig. 11/12

Fig. 13/14

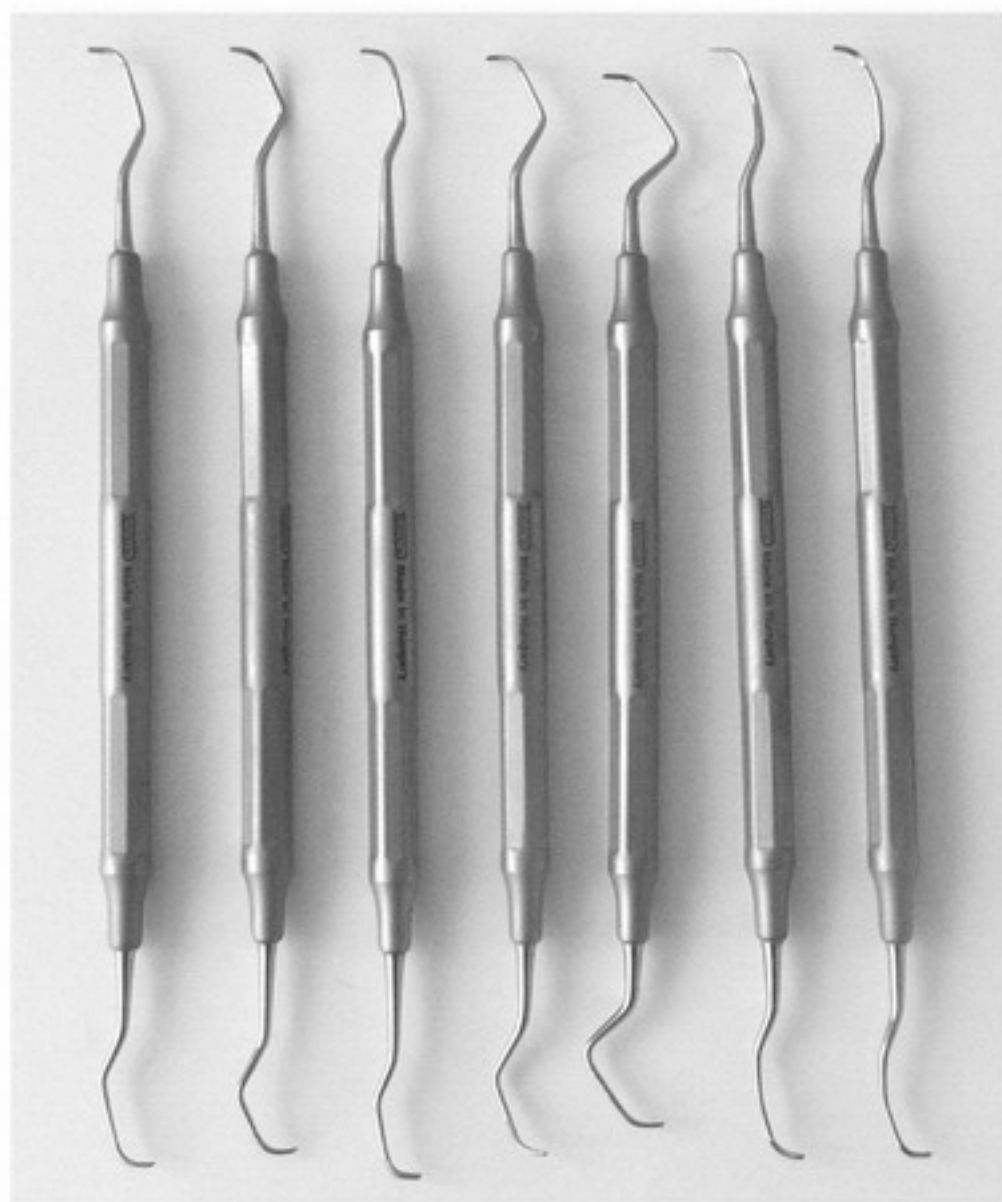

FOGKÓKAPARÓK - ZAHNREINIGER - SCALERS



.../HG

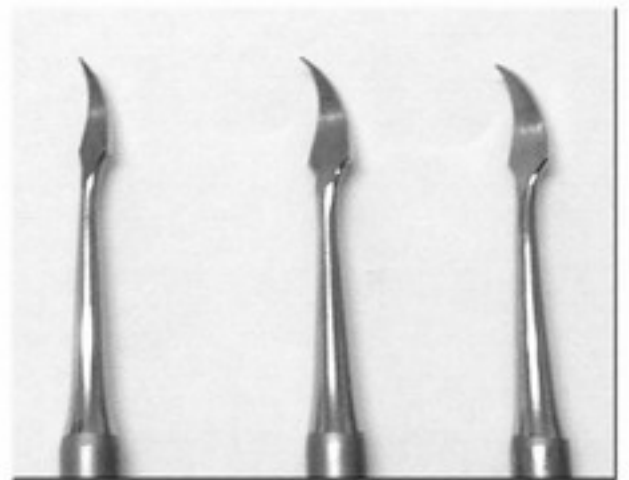

DB 1329

DB 1328

DB 1327



DB 1252

DB 1257

DB 1317

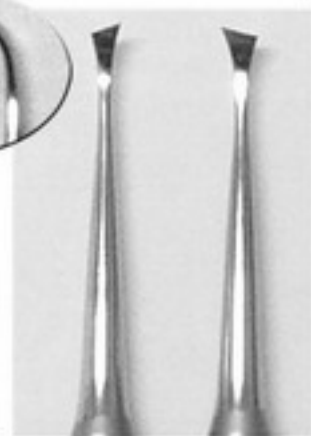

DB 1103

DB 1104



DB 1105

DB 1106



DB 1101

DB 1102

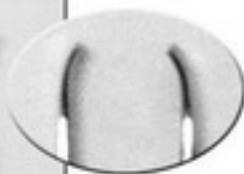



AN 1709

NYELVFOGÓ
 ZUNGEN ZANGE
 TONGUE HOLDING FORCEPS
 15 cm



OR 100

ORRTERPESZTŐ HART-MANN
 HART-MANN NASENSPEKULA
 HART-MANN NASAL SPECULA
 17 cm



Roser - König
 16 cm / 6 1/4"
 OM 149

SZÁJTERPESZTŐK
 MUNDSPERRER
 MOUTH GAGS



OM 130
 Heister
 13 cm / 5"

FOGGYÖKÉREMELŐK -

ZAHNWURZELHEBER -

ROOT ELEVATORS



DL 146
3 mm



DL 111
2 mm



DL 115
3 mm



DL 120
4 mm

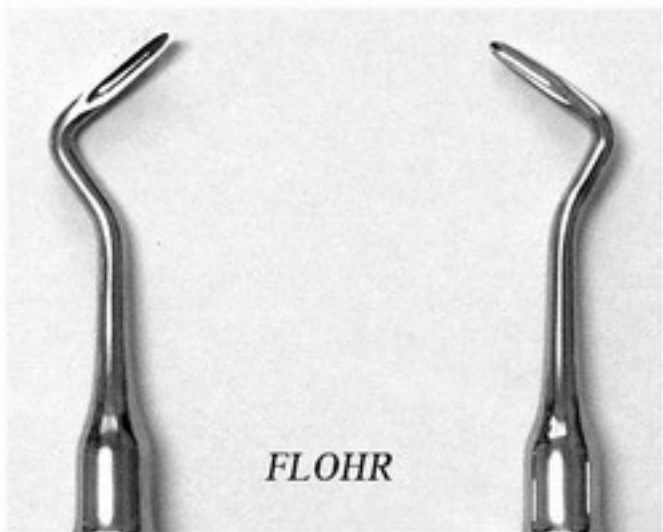

DL 1238

3 mm

DL 1239



DL 1236

3 mm



DL 1237

FLOHR

FOGGYÖKÉREMELŐK -



DL 132
2 mm
FLOHR



DL 133
3 mm
FLOHR



DL 134
4 mm
FLOHR

ZAHNWURZELHEBER -

ROOT ELEVATORS



DL 135
2 mm
BEIN



DL 136
3 mm
BEIN



DL 137
4 mm
BEIN



DL 138
3 mm
BEIN

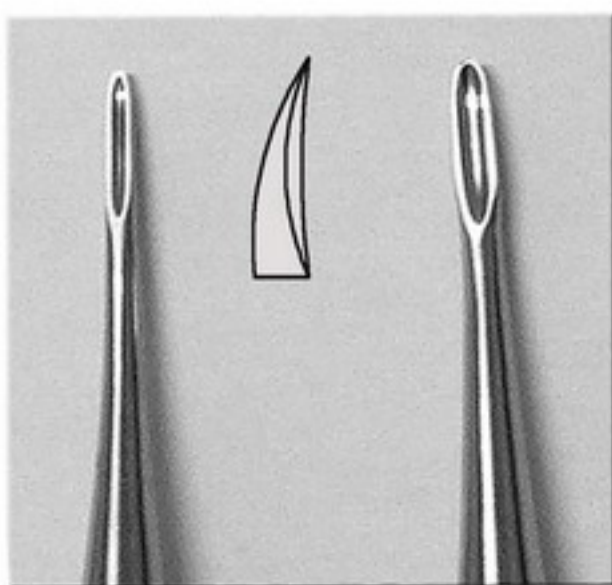

DL 162
3 mm
WHITE

DL 163
4 mm
WHITE

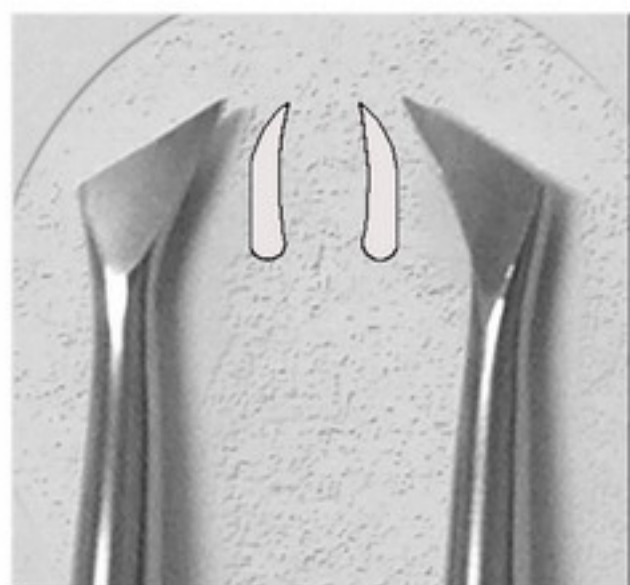

DL 1229

DL 1230

WINTER

FOGGYÖKÉREMELŐK -

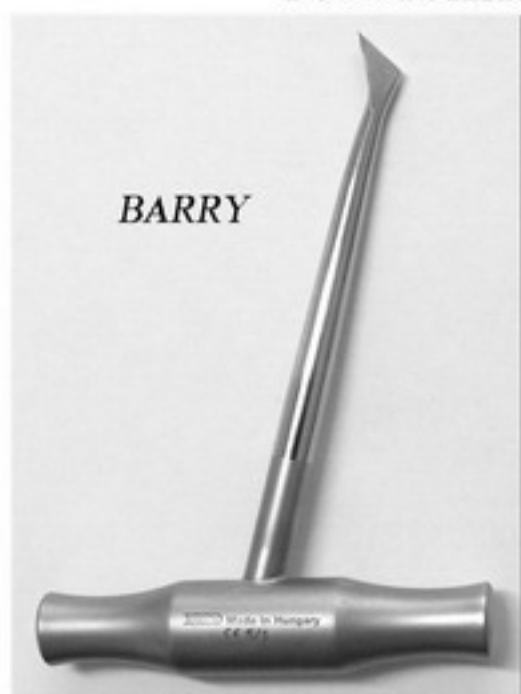

BARRY

ZAHNWURZELHEBER -

ROOT ELEVATORS



DL 1421

DL 1422



WINTER



DL 1427

DL 1428



DL 1409

DL 1410

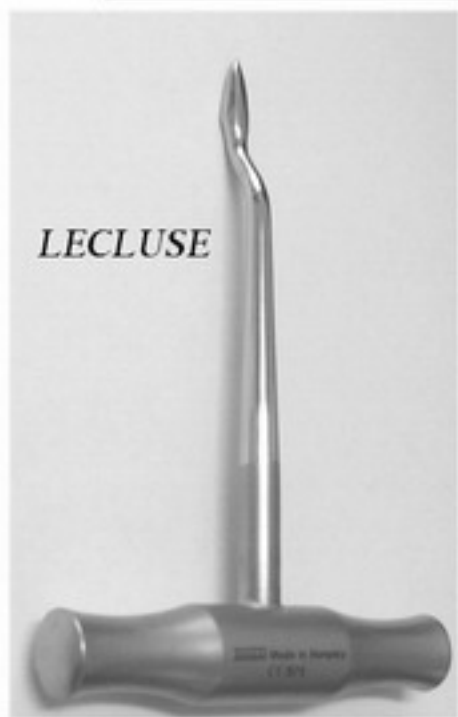

LECLUSE

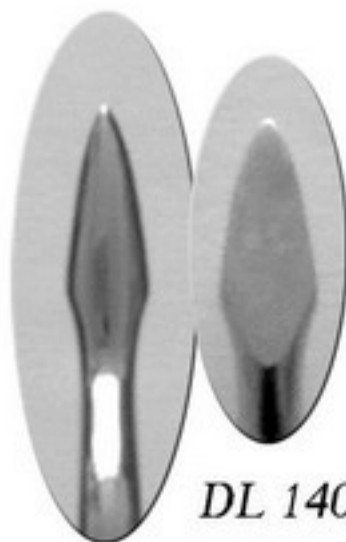

DL 1400

ÍRISZOLLÓK - IRISSCHEREN - IRIS SCISSORS



BC 156

10.5 cm

BC 1106

11.5 cm



BC 157

10.5 cm

BC 1107

11.5 cm



BC 1851 14.5 cm

BC 1852 18 cm

BC 1853 20 cm

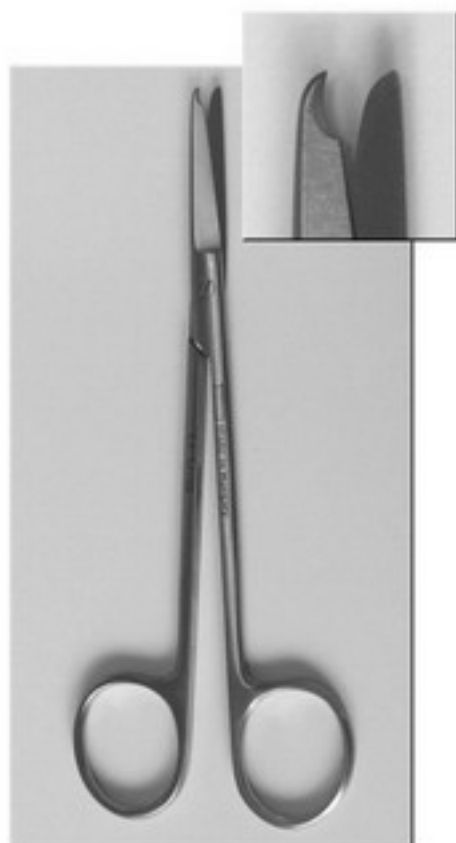
 KÖTSZEROLLÓ
 VERBANDSCHERE
 BANDAGE SCISSORS

BC 1802 11 cm

BC 1803 14.5 cm

 SPENCER
 VARRATSZEDŐ OLLÓ
 LIGATUR SCHERE
 LIGATURE SCISSORS

DO 1211

DO 1210

 FOGHÚS OLLÓ 12 cm
 ZAHNFLEISCHSCHERE
 GUM SCISSORS

SEBÉSZETI OLLÓK 14.5 cm -**CHIRURGISCHE SCHEREN 14.5 cm -****SURGICAL SCISSORS 14.5 cm****EGYENES - GERADE - STRAIGHT****BC 1314****BC 1324****BC 1344****HAJLÍTOTT - GEBOGEN - CURVED****BC 1414****BC 1424****BC 1444**

16.

SZÁJSEBÉSZETI OLLÓK
SCHERE FÜR STOMATOLOGIE
SCISSORS FOR STOMATOLOGY



LA GRANGE
11 cm

BC 1000



GOLDMANN-FOX
13 cm

BC 1001

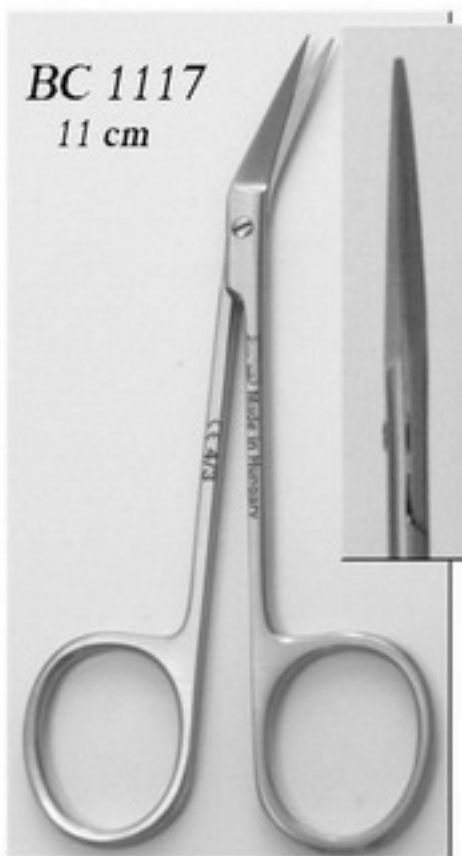

BC 1117
11 cm

VARRATSZEDŐ OLLÓ
LIGATUR SCHERE
LIGATURE SCISSORS

BC 1156



JOSEPH
14 cm

BC 1157





egyenes
gerade
straight



hajlított
gebogen
curved

BC 1119

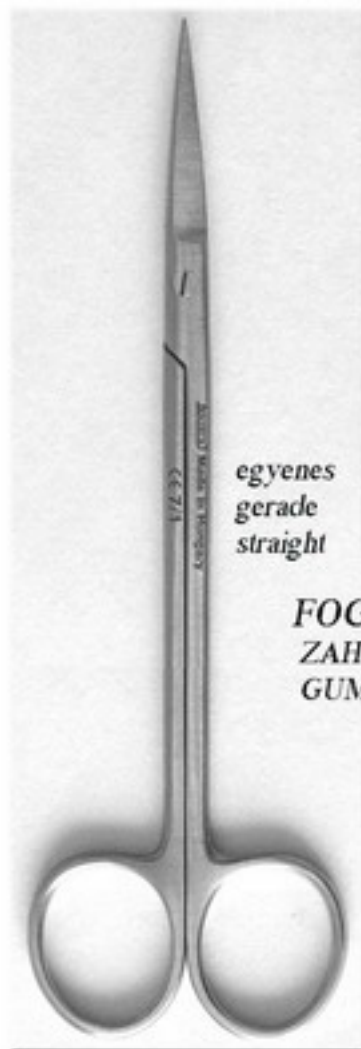

egyenes
gerade
straight

**BC 1175
KELLY**

16 cm

FOGHÚSOLLÓK
ZAHNFLEISSCHEREN
GUM SCISSORS



hajlított
gebogen
curved

**BC 1174
KELLY**

16 cm



egyenes
gerade
straight

BC 1114



hajlított
gebogen
curved

BC 1115

**METZENBAUM-FINO OLLÓ
METZENBAUM-FINO-SCHERE
METZENBAUM-FINO SCISSOR
14,5 CM**

**METZENBAUM-FINO OLLÓ
METZENBAUM-FINO-SCHERE
METZENBAUM-FINO SCISSOR
18 CM**



BT 1400
18.5 cm

SEBKAMPÓ BALOGH-FÉLE
WUNDHAKEN NACH BALOG
RETRACTORS BALOGH

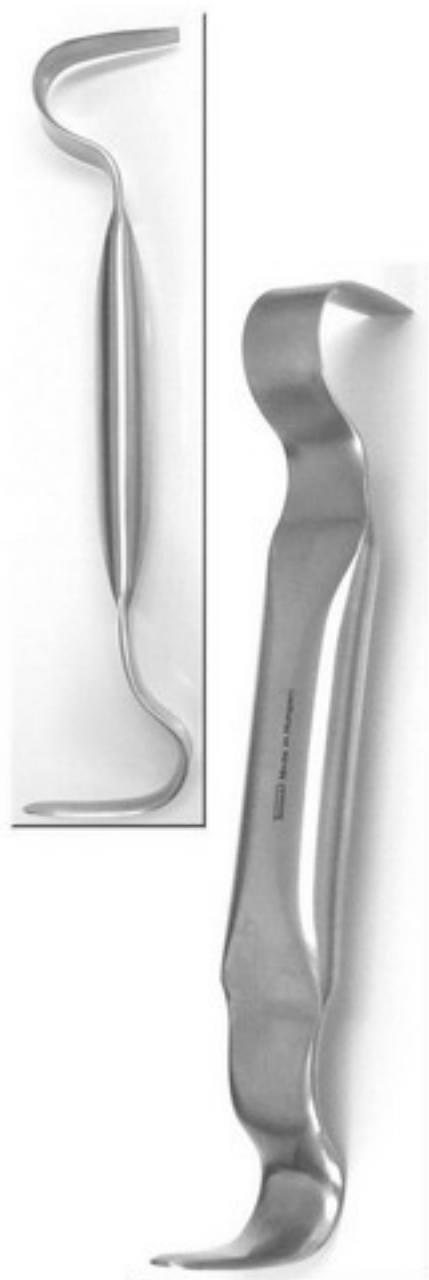

SEBKAMPÓ
WUNDHAKEN
RETRACTORS
BT 1401 19.5 cm

SZÁJZUGKAMPÓK - MUNDHAKEN - RETRACTORS



OM 1205
 NYELVLAPOC
 ZUNGENSPEL
 TONGUE SPATULAS
 16 cm



BT 1404	BT 1405	BT 1406
15 x 15 mm 200 mm 8"	20 x 22 mm 210 mm 8 ^{1/2} "	26 x 30 mm 230 mm 9"

SZÁJSEBÉSZETI KAMPÓ, TOMPA
 WUNDHAKEN, STUMPF
 RETRACTOR, BLUNT

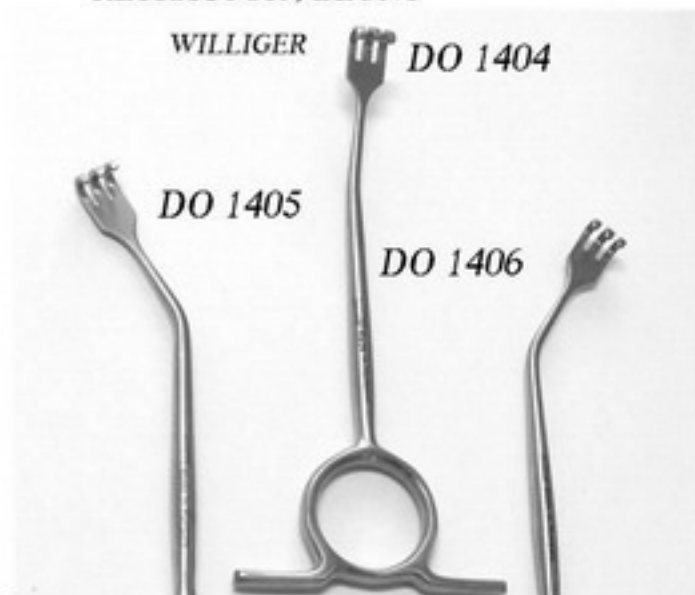

WILLIGER DO 1404

DO 1405

DO 1406



MIDDENDORFF

HEGYES
 SHARF
 SHARP

BT 1111



BT 1112



BT 1113



BT 1114



SEBKAMPÓK
 WUNDHAKEN
 RETRACTORS



160 mm

TOMPA
 STUMPF
 BLUNT

BT 1116



BT 1117



BT 1118



BT 1119



SEBKAMPÓK - WUNDHAKEN - RETRACTORS

KOCHER - LANGENBECK

21.5 cm



BT 1354 25 x 6 mm



BT 1356 35 x 8 mm



BT 1357 35 x 11 mm



BT 1358 35 x 15 mm



BT 1359 41 x 11 mm



BT 1361 55 x 11 mm

BT 1320 28 x 10 mm



BT 1321 28 x 14 mm



BT 1322 33 x 14 mm



BT 1323 28 x 16 mm



BT 1325 40 x 10 mm



BT 1326 40 x 13 mm

LANGENBECK
21 cm / 8 1/8"

SEBKAMPÓK - WUNDHAKEN - RETRACTORS**VOLKMANN**

18.5 cm



BT 1342 38 x 10 mm
BT 1343 36 x 15 mm
BT 1344 35 x 20 mm
BT 1345 34 x 25 mm
BT 1346 33 x 30 mm

**CUSHING**

22.5 cm



BT 1408 25 x 27 mm

VESTIBULUM KAMPÓ
VESTIBULUM HAKEN - VESTIBULUM RETRACTOR

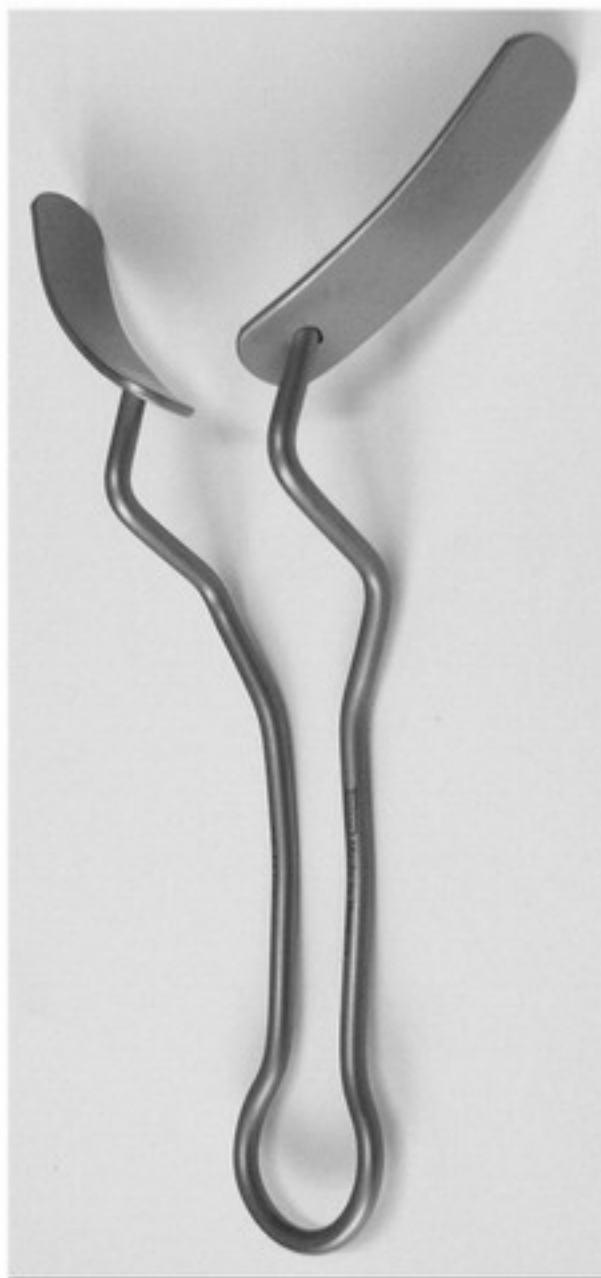

VT 100

*felső
obere
upper*



VT 101

*also
untere
lower*

ÉLESKANALAK - SCHARFE LÖFFEL - BONE CURETTES



VOLKMANN - FÉLE
17 cm / 6^{3/4}"



fig. 0000

FK 1630

2,3 x 3,5

fig. 000

FK 1631

3 x 4,6

fig. 00

FK 1632

4 x 6,2

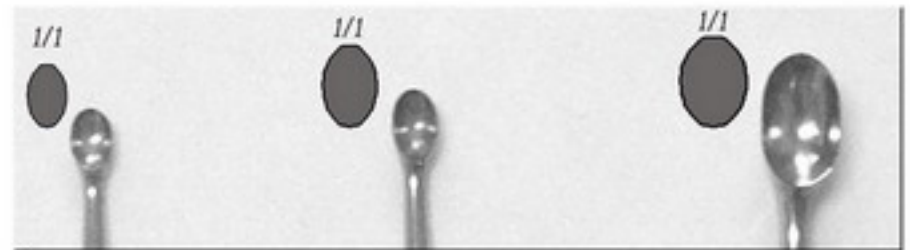

fig. 0

FK 1633

5 x 8

fig. 1

FK 1634

7 x 10,5

fig. 2

FK 1635

8,6 x 11,6



KERPER - FÉLE



DO 1653



DO 1654

LUCAS KANÁL
LUCAS SCHARFE LÖFFEL
LUCAS BONE CURETTES



1/1

DO 1630

2 x 3



1/1

DO 1631

2 x 3



1/1

DO 1632

2,5 x 4



1/1

DO 1633

2,5 x 4

ÉLESKANALAK - SCHARFE LÖFFEL -
BONE CURETTES
(DOUBLE ENDED, CURVED)

DO 1655

2,3 x 3,6

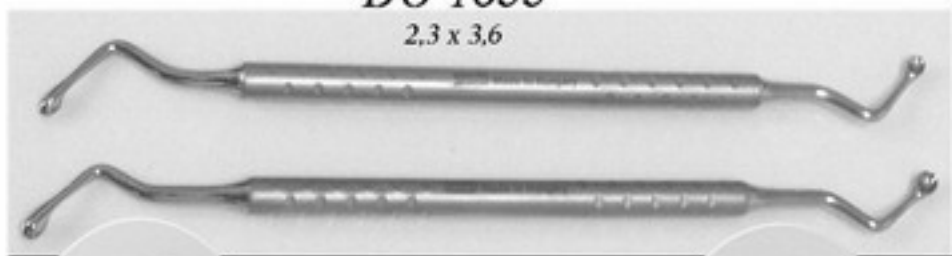

DO 1656

3 x 5



FK 1800

FK 1801

RASPATÓRIUM
RASPATORIES

6 mm



Williger

FK 1121
ELEVATÓRIUM
ELEVATOREN
ELEVATOR



FK 1300

Williger

4,5 mm



FK 1301

Williger

Tompa/ éles
stumpf/ scharf
blunt/ sharp

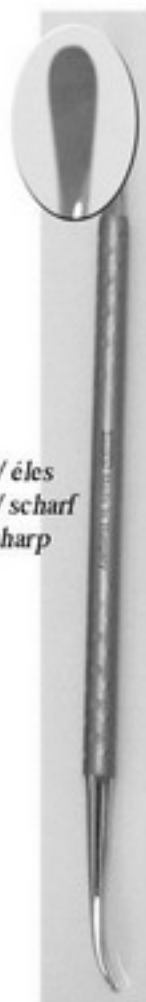

FK 1165

Freer



FK 1611

FK 1612

Partsch

TÚFOGÓK - NADELHALTER - NEEDLE HOLDERS



BM 1234	13 cm
BM 1235	16 cm
BM 1236	18 cm
BM 1237	20 cm

KEMÉNYFÉM BETÉTÉS
TC



BM 2234	13 cm	TC
BM 2235	16 cm	TC
BM 2236	18 cm	TC
BM 2237	20 cm	TC

BM 1360	14 cm
BM 1361	17 cm
BM 1362	20 cm

KEMÉNYFÉM BETÉTÉS
TC



BM 2360	14 cm	TC
BM 2361	17 cm	TC
BM 2362	20 cm	TC

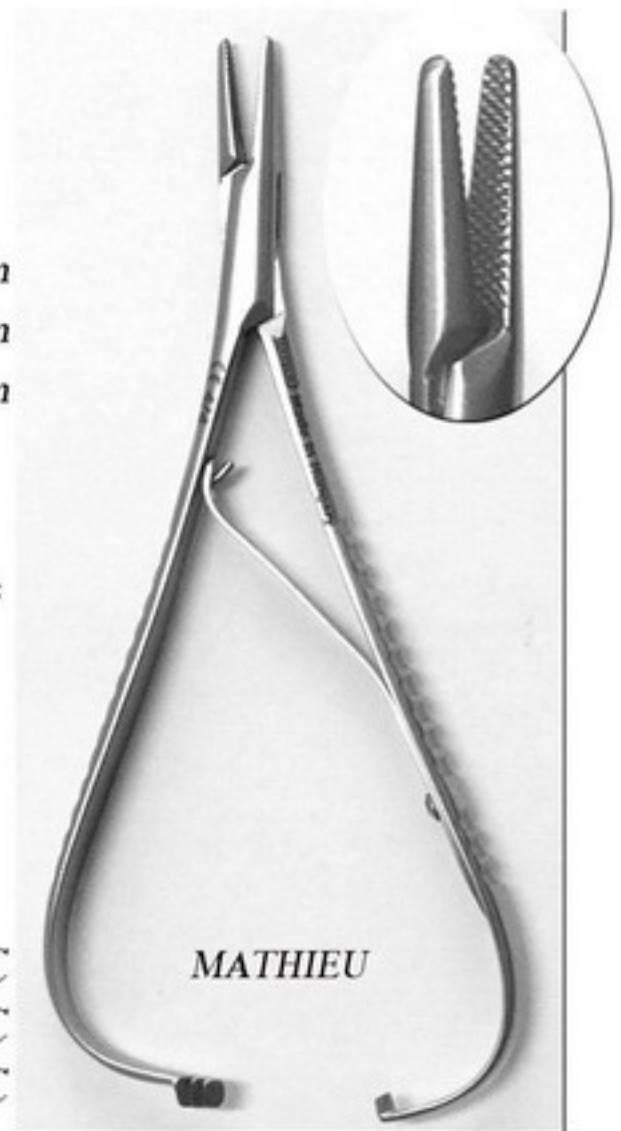

CEMENTSPATULA -



.../HG

DF 1150
4.5 mm

ZEMENTSPATELN -

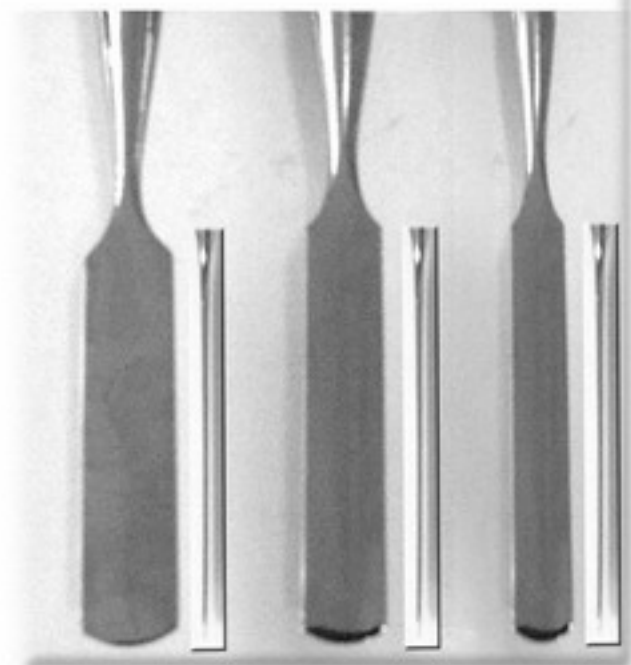
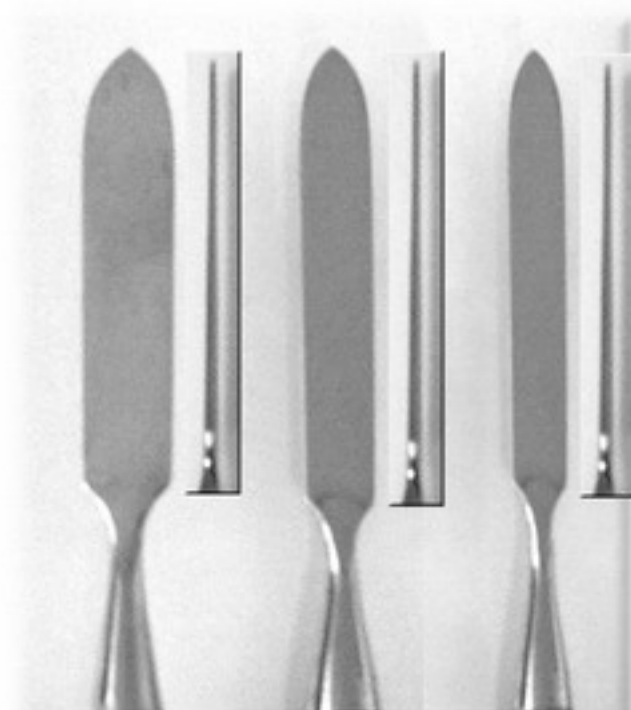
CEMENT SPATULAS
DOUBLE-ENDEDDF 1165
7.5mmDF 1163
6 mmDF 1161
5 mm

KOMPOZIT TÖMÖMŰSZEREK TITANNITRID BEVONATTAL
COMPOSITE FÜLLÜNGSINSTRUMENTE MIT TITANNITRIDBESCHICHTUNG -
COMPOSITE MODELLING INSTRUMENTS WITH TITANIUM NITRIDE
NON-STICK PROTECTIVE COATING

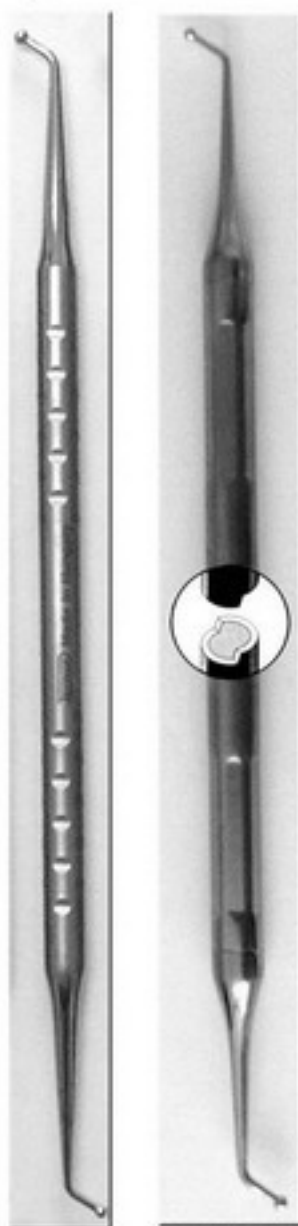
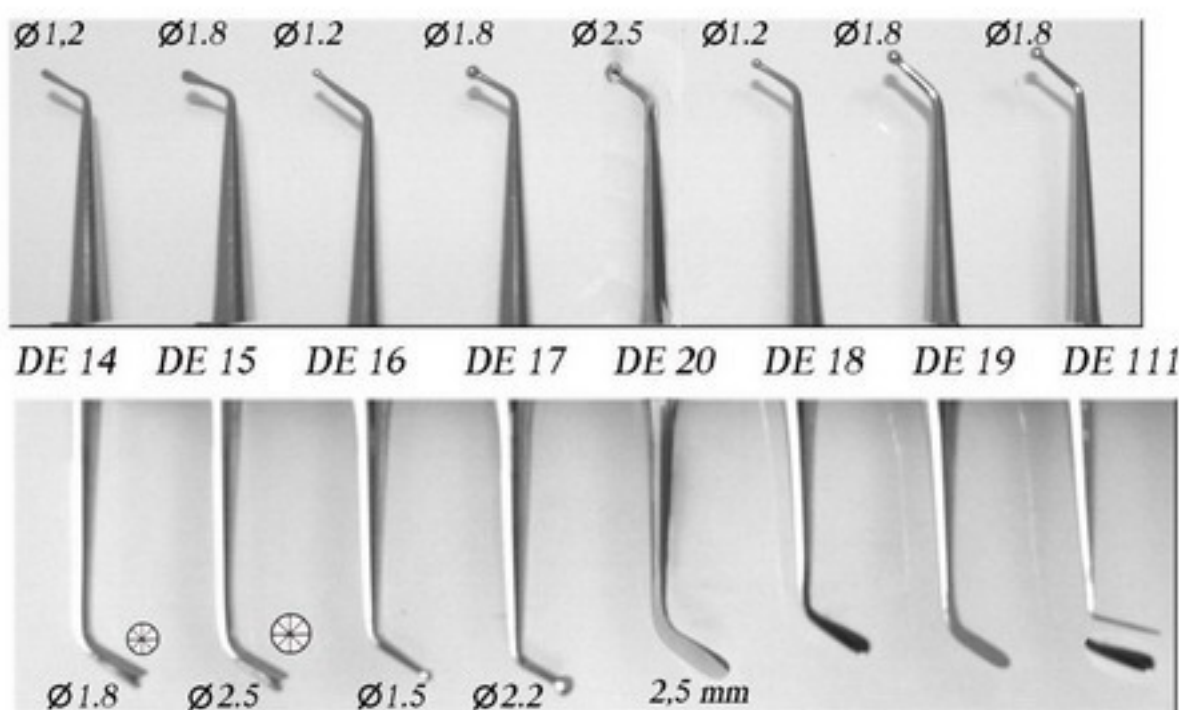

FOGTÖMŐK - FÜLLUNGSINSTRUMENTE - FILLING INSTRUMENTS

DE 17

.../HG

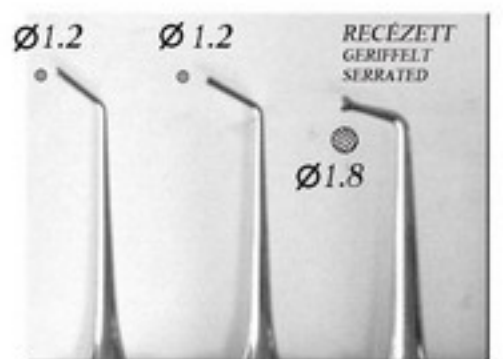

DE 124 DE 122 DE 1666

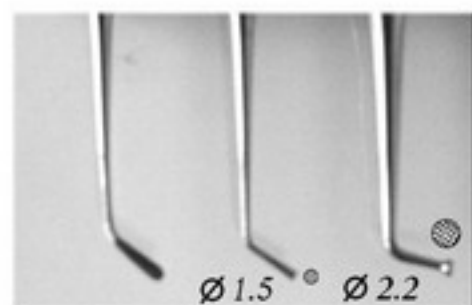
 RECÉZETT
GERIFFELT
SERRATED

FOGTÖMŐK - FÜLLUNGSINSTRUMENTE - FILLING INSTRUMENTS

$\varnothing 1,2$ $\varnothing 1,8$ $\varnothing 1,2$ $\varnothing 1,8$ $\varnothing 1,2$ $\varnothing 1,8$ $\varnothing 2,5$
 DE 1110 DE 1111 DE 1113 DE 1114 DE 1125 DE 1126 DE 1127

2,5 mm 2,5 mm 2,5 mm 2,5 mm $\varnothing 1,5$ $\varnothing 2,2$ $\varnothing 3,5$

$\varnothing 1,8$ $\varnothing 2,5$ $\varnothing 1,2$ $\varnothing 1,8$ $\varnothing 2,5$
 DE 1101 DE 1102 DE 1107 DE 1108 DE 1109

$\varnothing 2,2$ $\varnothing 3,5$ $\varnothing 1,5$ $\varnothing 2,2$ $\varnothing 3,5$

.../HG

FOGTÖMŐK - FÜLLUNGSINSTRUMENTE - FILLING INSTRUMENTS

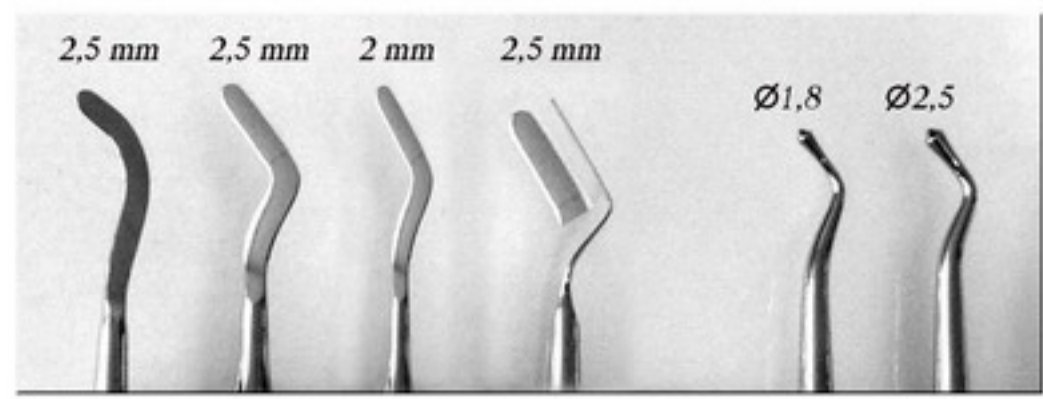

DE 1431 DE 1422 DE 1421 DE 1423 DF 121 DF 122

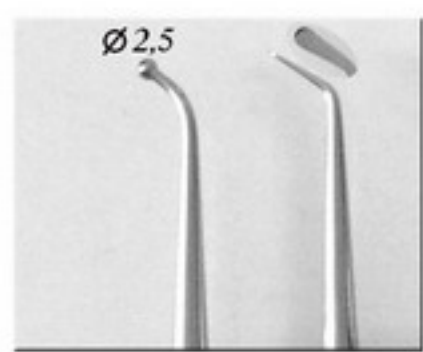
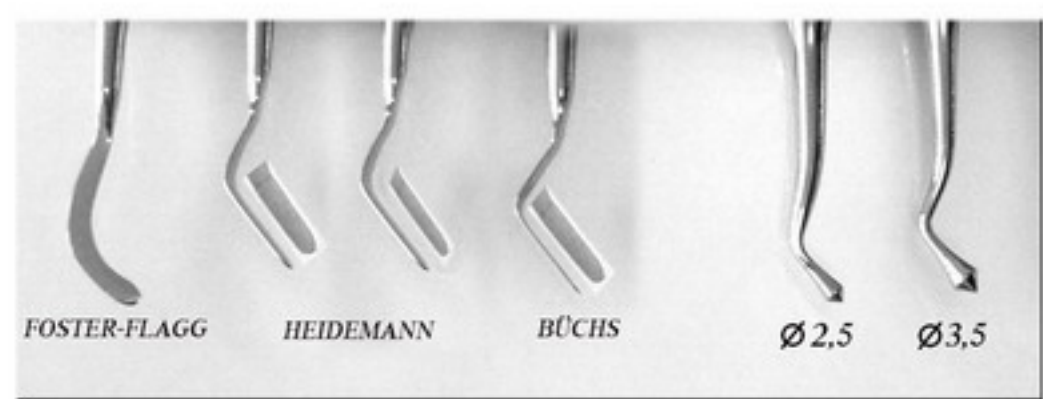

DE 1297 DE 130

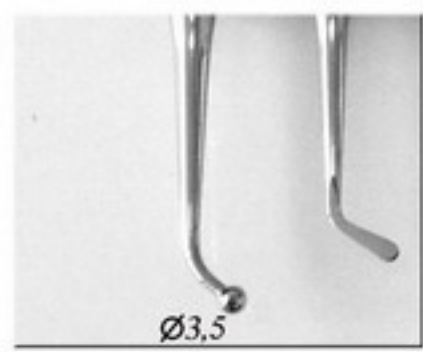

.../HG

GYÖKÉRTÖMŐK -

NERVEN INSTRUMENTE - NERVE INSTRUMENTS

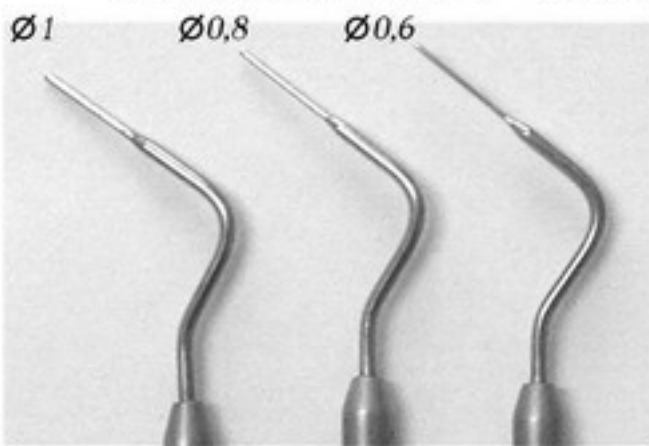

DD 9

DD 8

DD 7



DO 1305

DO 1301

Luniatschek
18.5 cm / 7^{1/4}"

TAMPONVIVŐ
TAMPONSTOPFER
GAUZE PACKER



Ø2,5

Ø 1,8

Vajna

DF 100

TÖMŐ-SIMITÓ
FÜLLUNGSINSTRUMENTE
FILLING INSTRUMENTS



.../HG



DF 116

AMALGÁM PISZTOLY
AMALGAM PISTOLE
AMALGAM CARRIERS

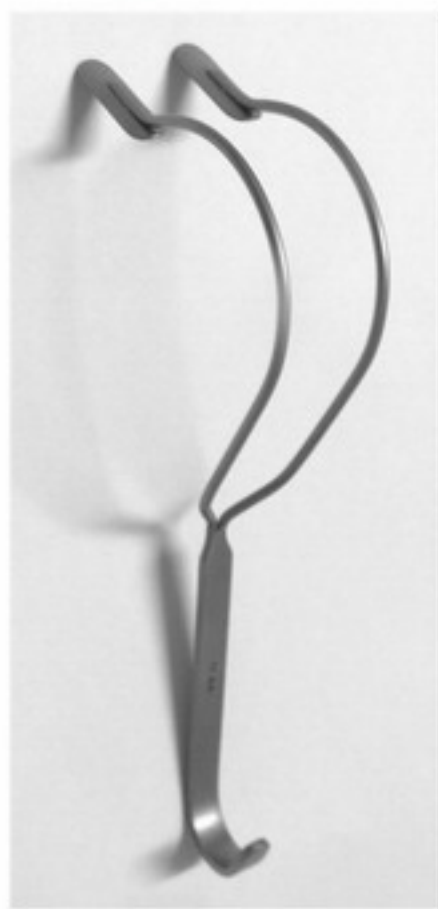

DD 10

VATTATEKERCS LESZORÍTÓ
WATERROLLENHALTER
COTTON PUSHER



DO 1306
FONALBEVIVŐ
FADENSTOPFER
RETRACTION
PACKER



DF 1346 5 mm

DF 1348 7 mm

MATRICAFESZÍTŐ
MATRIZEN SPANNER
MATRIX RETAINERS



DF 1349

MATRICAFESZÍTŐ
MATRIZEN SPANNER
MATRIX RETAINERS IVORY

EXKAVÁTOROK - EXKAVATOREN - EXCAVATORS

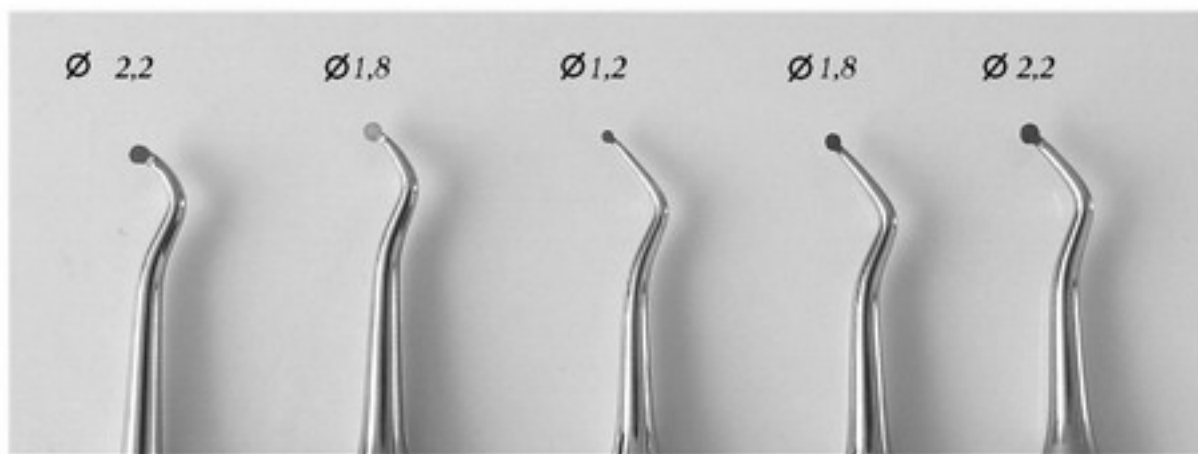

DC 1239 DC 1241 DC1271 DC 1275 DC1279



.../HG



OM 13



OM 12

UJJVÉDŐ, FÉM
FINGERSCHÜTZER, METALL
FINGER PROTECTOR



OM 11

FOGHÚSSZÉL-KÉSEK -



2 mm

DC 161 DC 162



1,5 mm

DC 163 DC 164

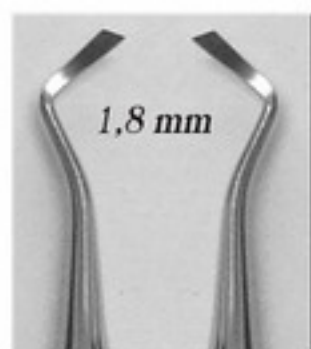

1,8 mm

DC 177 DC 178



1,8 mm

DC 179 DC 180

ZAHNFLEISCHMESSER
BLACK CUTTING
INSTRUMENTS



.../HG

ZOMÁNC VÉSŐK - SCHMELZMEISSEL
ENAMEL CHISELS

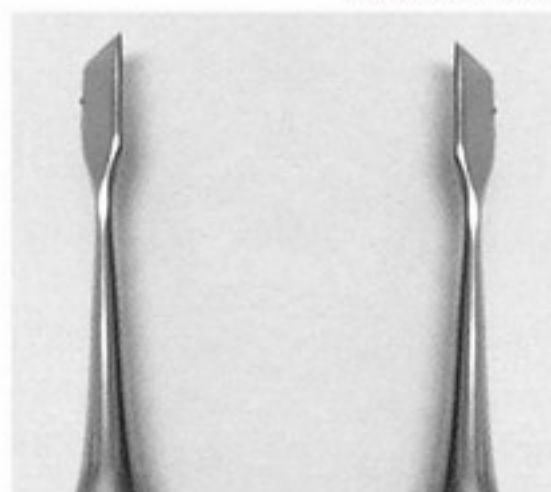

DC 151 3 mm DC 152



DC 181 3 mm

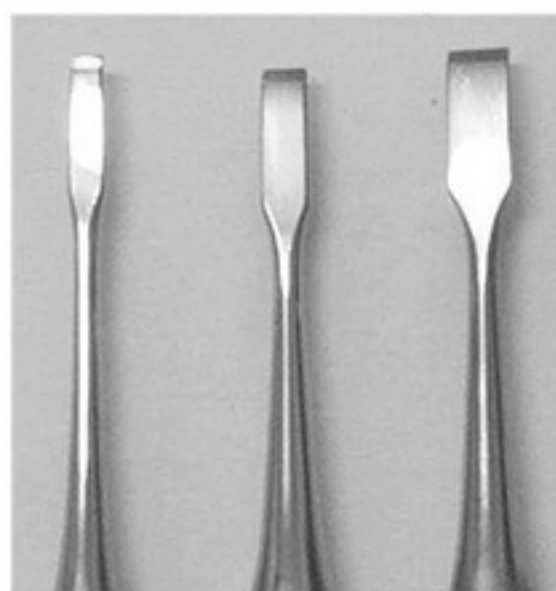

DC 185 2 mm DC 184 3 mm DC 183 4 mm

ÉRFOGÓK - ARTERIENKLEMMEN - HAEMOSTATIC FORCEPS



EGYENES HORGAS
GERADE MIT ZAHNE
STRAIGHT WITH HOOK

- BH 1612 HALSTED MOSQUITO 12.5 cm
- BH 1614 CRILE 14 cm
- BH 1642 CRILE 16 cm
- BH 1644 HALSTED 18 cm



HAJLÍTOTT HORGAS
GEBOGEN MIT ZAHNE
CURVED WITH HOOK

- BH 1613 HALSTED MOSQUITO 12.5 cm
- BH 1615 CRILE 14 cm
- BH 1643 CRILE 16 cm
- BH 1645 HALSTED 18 cm

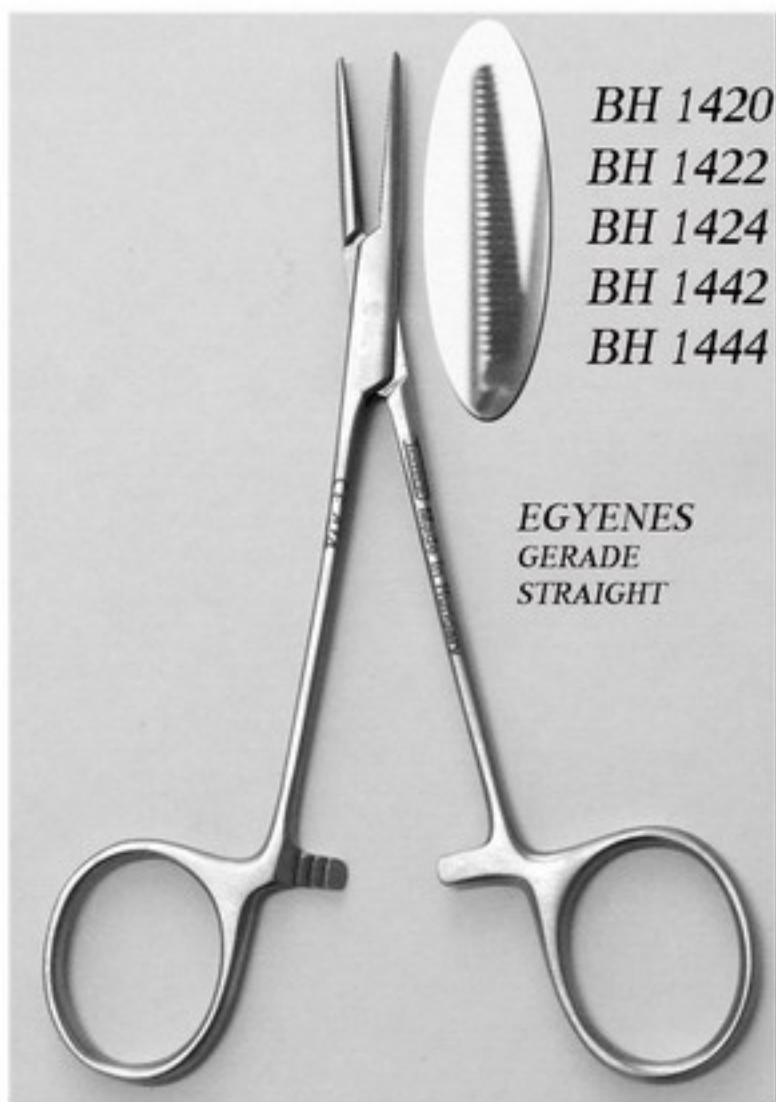
ÉRFOGÓK - ARTERIENKLEMMEN - HAEMOSTATIC FORCEPS

BH 1420

BABY MOSQUITO 10 cm

BH 1422

HALSTED MOSQUITO 12.5 cm

BH 1424

CRILE 14 cm

BH 1442

CRILE 16 cm

BH 1444

HALSTED 18 cm

EGYENES
 GERADE
 STRAIGHT

BH 1421 BABY MOSQUITO 10 cm

BH 1423 HALSTED MOSQUITO 12.5 cm

BH 1425 CRILE 14 cm

BH 1443 CRILE 16 cm

BH 1445 HALSTED 18 cm

HAJLÍTOTT
 GEBOGEN
 CURVED

SZEMÉSZETI SZIKÉK - AUGENSKALPELLE - SCALPELS



BA 1401 BA 1402 BA 1403 BA 1404 BA 1407 BA 1408



BA 1409 BA 1410 BA 1411



SEBÉSZETI SZIKÉK - CHIRURGISCHE SKALPELLE - SURGERY KNIVES

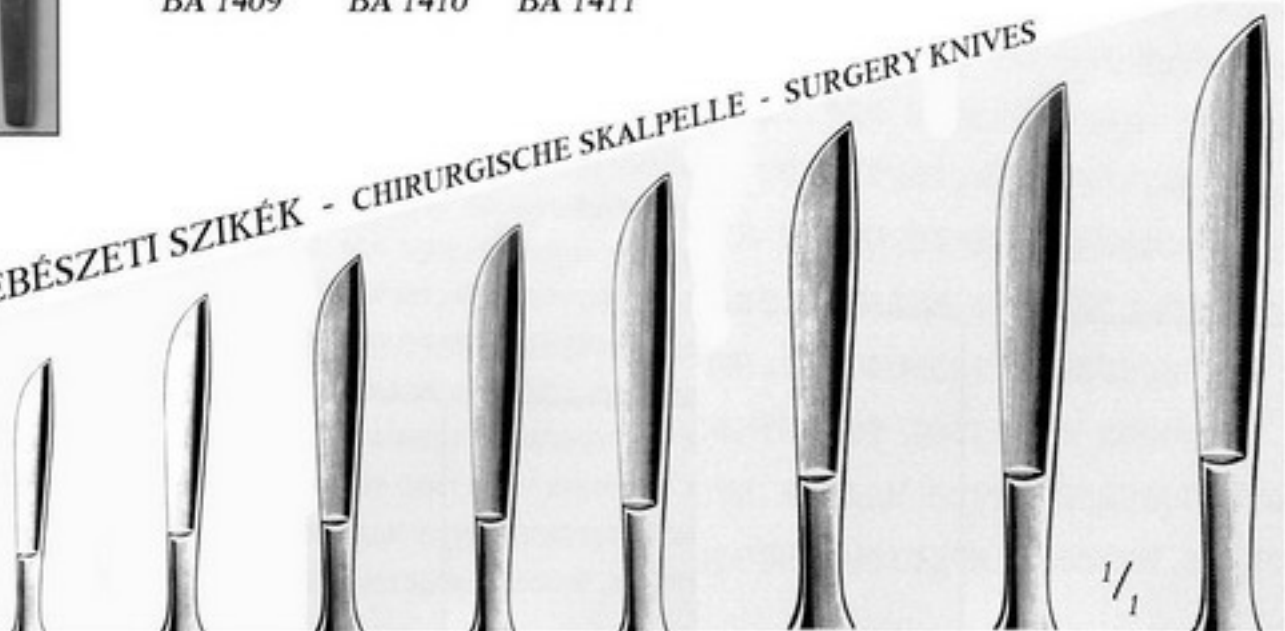

BA 1501 BA 1502 BA 1503 BA 1504 BA 1505 BA 1507 BA 1508 BA 1509

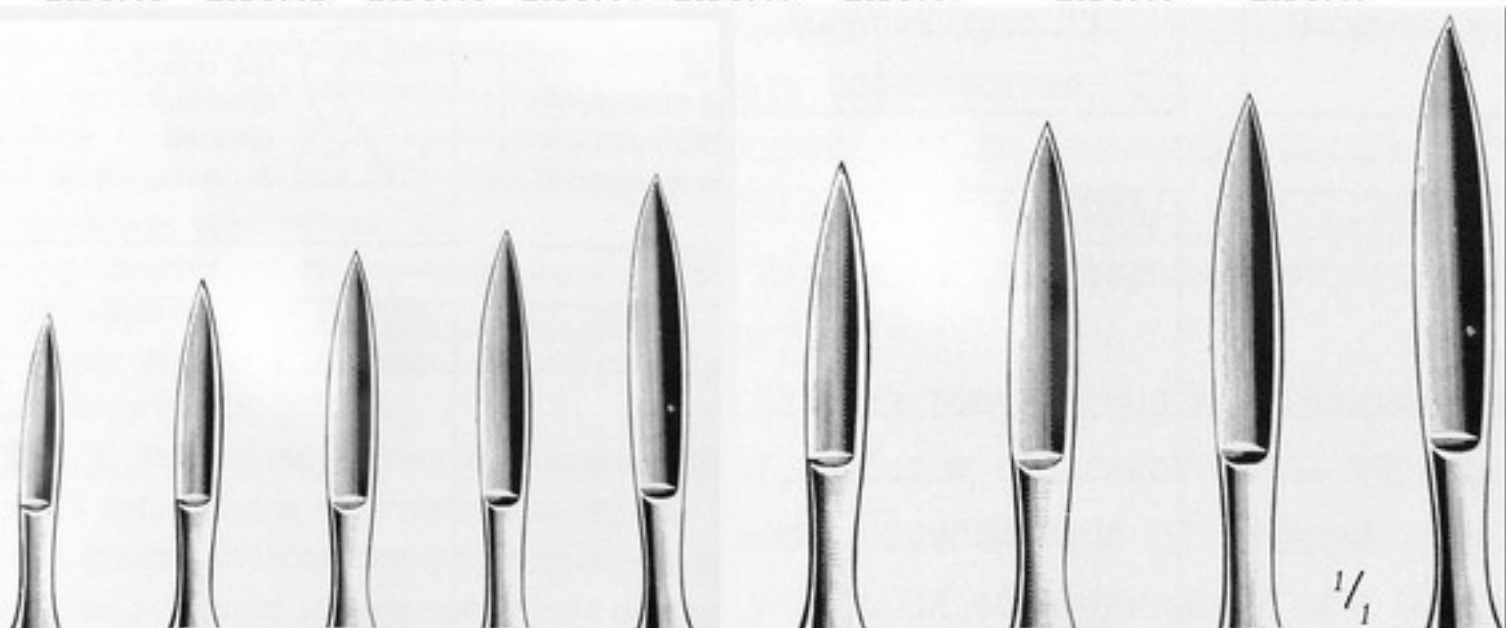

BA 1510 BA 1511 BA 1512 BA 1513 BA 1514 BA 1515 BA 1516 BA 1517 BA 1518

FOGHÚZÓ FOGÓK - ZAHNZANGE - EXTRACTING FORCEPS



1



2

DG 40/...

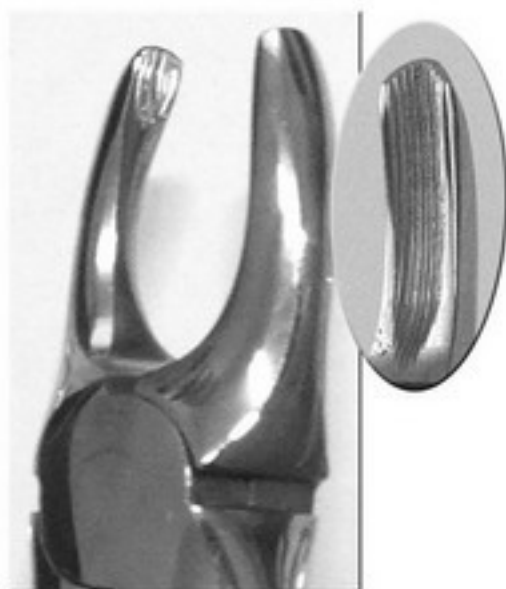

3

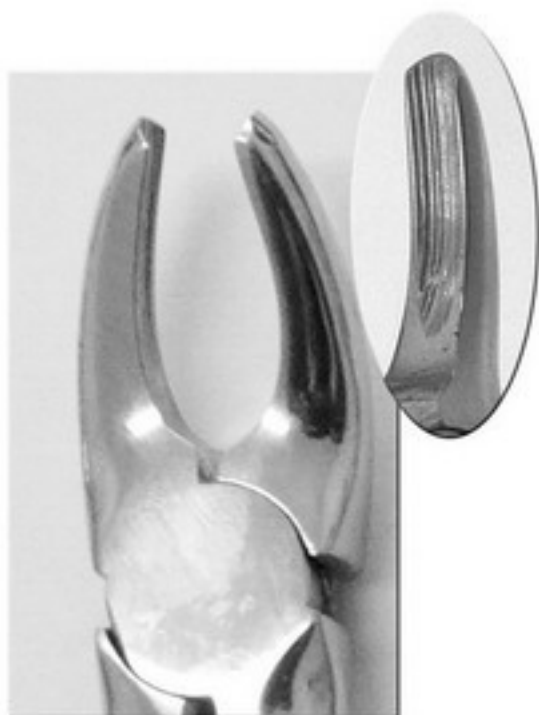

7



8



13



4

FOGHÚZÓ FOGÓK - ZAHNZANGE - EXTRACTING FORCEPS



18

DG 40/...



18 A



17



22



19



20



21

FOGHÚZÓ FOGÓK - ZAHNZANGE - EXTRACTING FORCEPS

DG 40/...



29



30



23



24

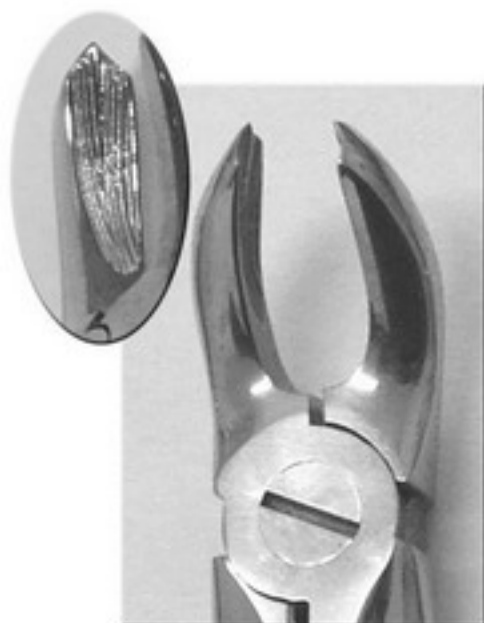

32



31

FOGHÚZÓ FOGÓK - ZAHNZANGE - EXTRACTING FORCEPS

DG 40/...



52 A



51 A



51



52



51 L



67



56



55

42.

DG 40/...

FOGHÚZÓ FOGÓK - ZAHNZANGE - EXTRACTING FORCEPS



33

33 A

33 B



41

44



45

INYLEVÁLASZTÓ
ZAHNFLEISCHABTRENNER
SPECIAL GUM KNIFE

DD 11



FOGHÚZÓ FOGÓK - ZAHNZANGE - EXTRACTING FORCEPS

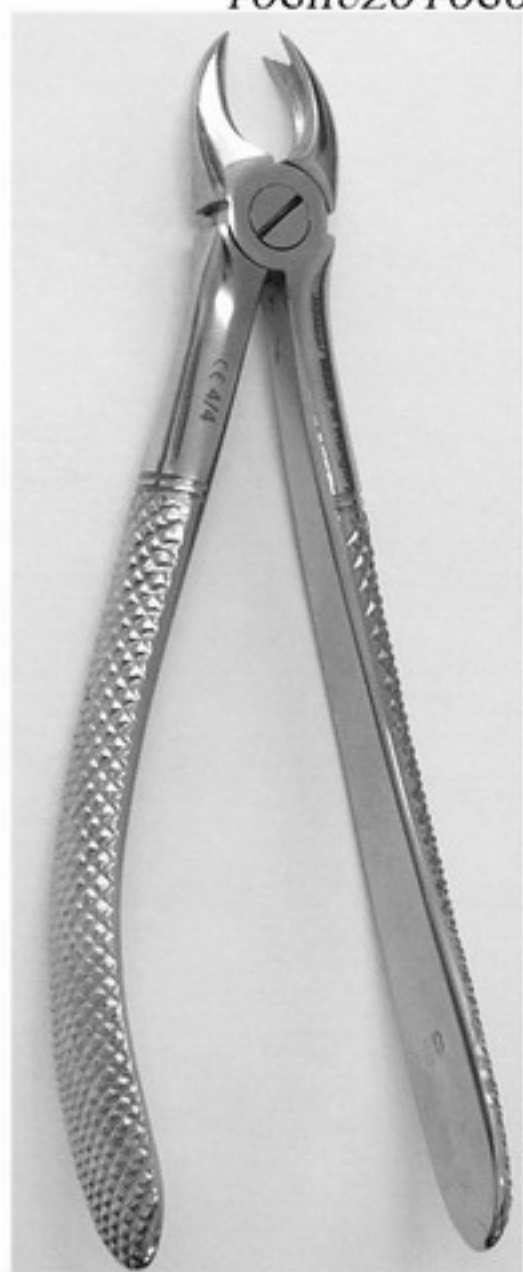

DG 40/...



89

90



79

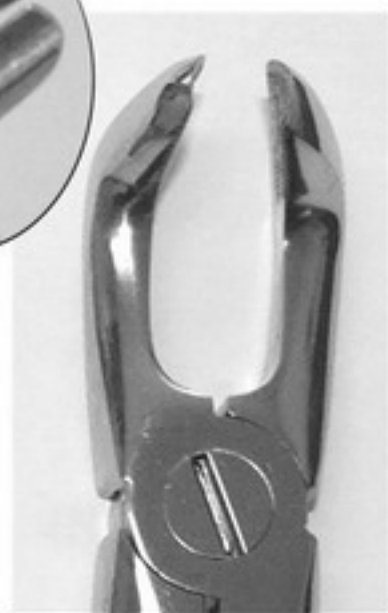

79 A

GYERMEK FOGHÚZÓ FOGÓK - KINDER ZAHNZANGE -
EXTRACTING FORCEPS FOR CHILDREN

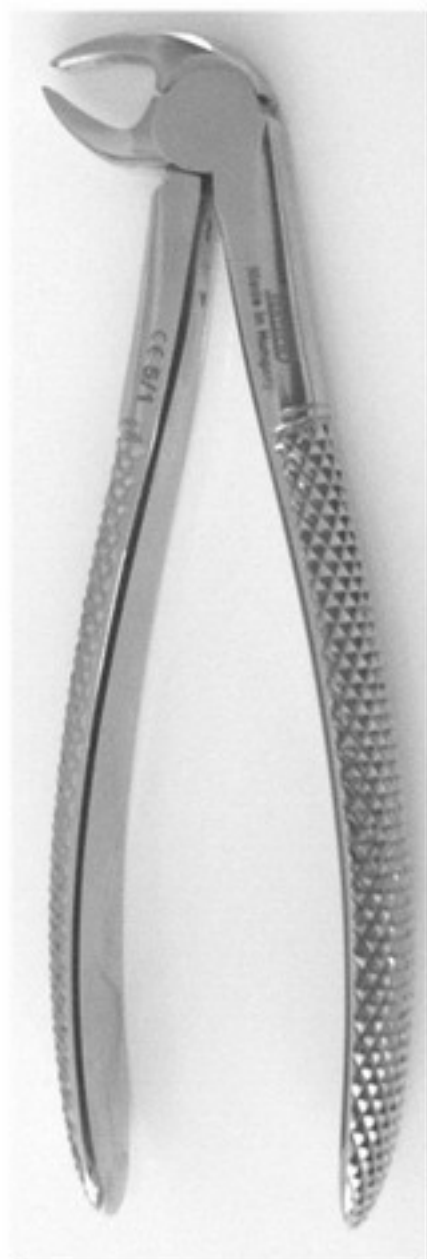

13 S



33 S



DG 40/...



22 S



38



37



29 S



GYERMEK FOGHÚZÓ FOGÓK - KINDER ZAHNZANGE -
EXTRACTING FORCEPS FOR CHILDREN

DG 40/...



39 R



39 L



39

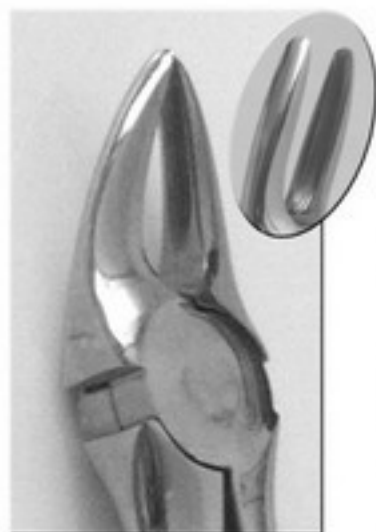

30 S

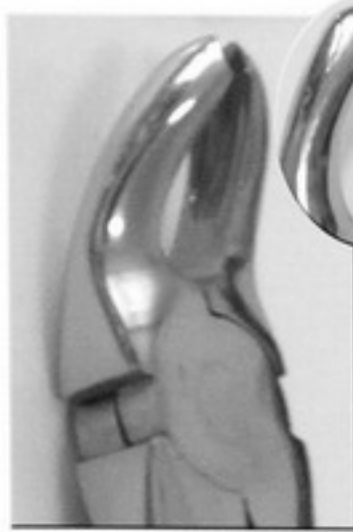

39 A



51 S



DG 40 / 100

TEJFOG CSIPESZ
MILCHZAHNPINZETTE
TWEezer FOR CHILDREN

GYERMEK FOGHÚZÓ FOGÓK - KINDER ZAHNZANGE -

KLEIN féle EXTRACTING FORCEPS FOR CHILDREN



DK 901



DK 899



DK 897



DK 895



DK 910



DK 903



DK 905



GYÖKÉRSZILÁNK ELTÁVOLÍTÓ
WURZELSPITZENHEBER
ROOT TIP PICKS



MT 180

180 gr

MT 110

110 gr

FÉM KALAPÁCS TEFLONBETÉTEL
HAMMER MIT TEFLON EINSATZ
MALLETS WITH TEFLON INSERT



MS 180

180 gr

MS 110

110 gr

FÉM KALAPÁCS
HAMMER AUS METALL
MALLETS STAINLES STEEL

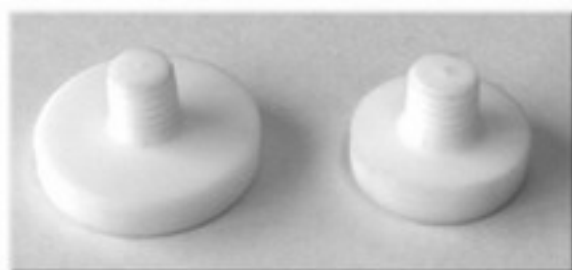

TEFLONBETÉT
TEFLON EINSATZ
TEFLON INSERT

MT 111 $d=20$ mm

MT 181 $d=25$ mm

LAPOS VÉSŐK -

FLACHMEISSEL -

BONE CHISELS AND GOUGES



- FL 1183 3 x 2 mm
- FL 1184 4 x 2,5 mm
- FL 1185 5 x 3 mm
- FL 1186 6 x 3 mm

Partsch

17 cm / 6^{3/4} "



- FL 1173 3 x 2 mm
- FL 1174 4 mm
- FL 1175 5 x 2,4 mm
- FL 1176 6 x 2,6 mm

Partsch

14 cm / 5^{1/2} "

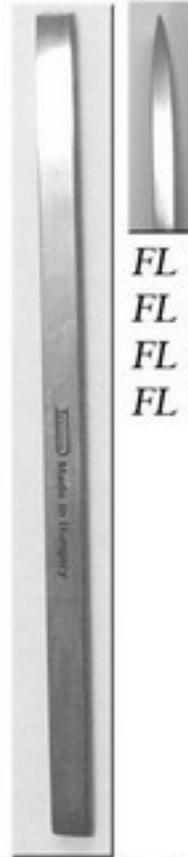

- FL 1101 4 x 2,3 mm
- FL 1102 6 x 2,3 mm
- FL 1104 8 x 2,3 mm
- FL 1106 10 x 2,3 mm

Lambotte

12 cm



- DD2 2 mm
- DD3 3 x 2,2 mm
- DD4 4 x 2,4 mm
- DD5 5 x 2,6 mm
- DD6 6 x 2,8 mm

Móczár
15 cm

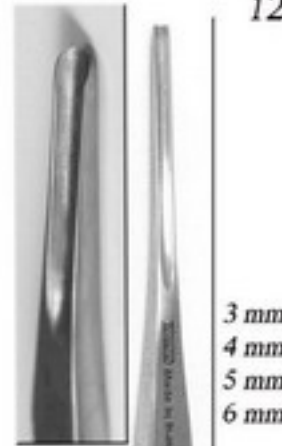

- 3 mm
- 4 mm
- 5 mm
- 6 mm

17 cm / 6^{3/4} "

- FL 1223
- FL 1224
- FL 1225
- FL 1226

14 cm / 5^{1/2} "

- FL 1213
- FL 1214
- FL 1215
- FL 1216

VÁJT VÉSŐ
HOHLMEISSEL
GOUGES



DP 1780
KORONA ELTÁVOLÍTÓ
"SZTRILICH"
KRONENABNEHMER MIT
FEDERN "SZTRILICH"
CROWN REMOVERS

DP 1781/5 195 mm
BOWDEN HOSSZÚ
DP 1781-HEZ
SCHLINGE LANG
FÜR DP 1781
LOOP LONG
FOR DP 1781

FEJ DP 1781-HEZ
KOPF FÜR DP 1781
HEAD FOR DP 1781

DP 1781/3-1 **DP 1781/3-2** **DP 1781/3-3**



DP 1781
UNIVERZÁLIS KORONAELTÁVOLÍTÓ
UNIVERSAL KRONENENTFERNER
UNIVERSAL CROWN REMOVER

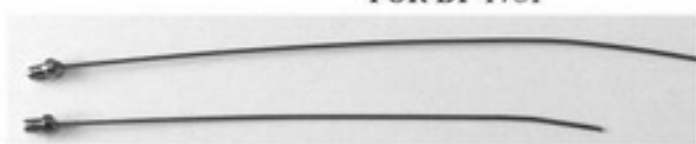

DP 1781/4 85 mm
BOWDEN RÖVID
DP 1781-HEZ
SCHLINGE KURZ
FÜR DP 1781
LOOP SHORT
FOR DP 1781



DP 1781/2
DUPLA HUOKRENDSZER
A DP 1781-HEZ
DOPPELSCHLAUFENSYSTEM
FÜR DP 1781
DOUBLE LOOP TIP FOR DP 1781



DP 1781/1
EGYSZERES HUOKRENDSZER
DP 1781-HEZ
EINZELSCHLAUFENSYSTEM
FÜR DP 1781
SIMPLE LOOP TIP FOR DP 1781

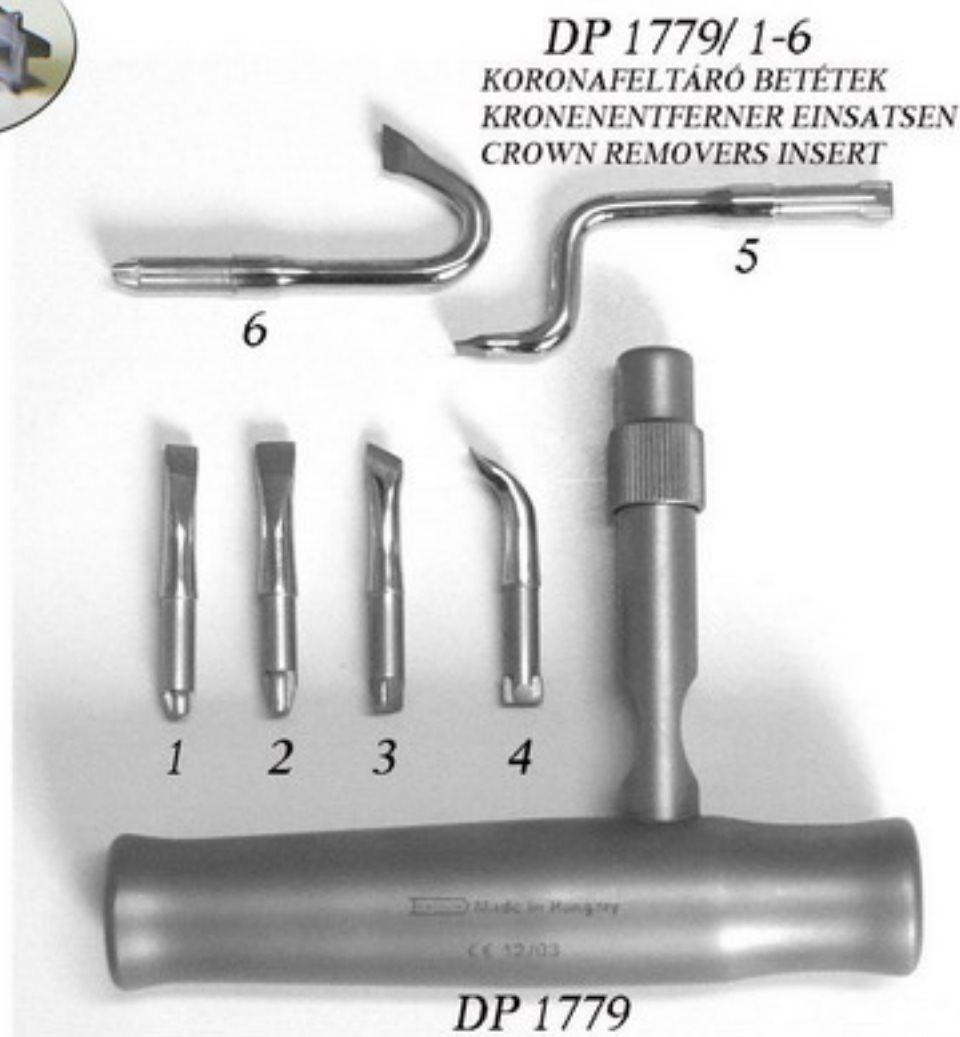

KORONAFELTÁRÓ 6db BETÉTTTEL
KRONENENTFERNER MIT 6 EINSATZEN
CROWN REMOVERS WITH 6 INSERT





DF 1760
VESETÁL 20 cm
NIERENSCHALE
KIDNEY DISHES



DF 1761 /...

MŰSZERTÁLCÁK	1	(19 X 10 X 1,5 cm)
INSTRUMENT TABLETTEN	2	(20 X 10 X 1 cm)
INSTRUMENT TRAYS	3	(20 X 15 X 1 cm)

DF 1762 PEREMES MŰSZERTÁLCÁK 32X22X2 Cm
INSTRUMENT TABLETTEN MIT RAND
INSTRUMENT TRAY WITH COLLAR

DF 1763 PERFORÁLT SZÉLŰ MŰSZERTÁLCÁK 29X18,5X1 cm
INSTRUMENT TABLETTEN MIT PERFORIERT RAND
INSTRUMENT TRAY PERFORATED EDGE

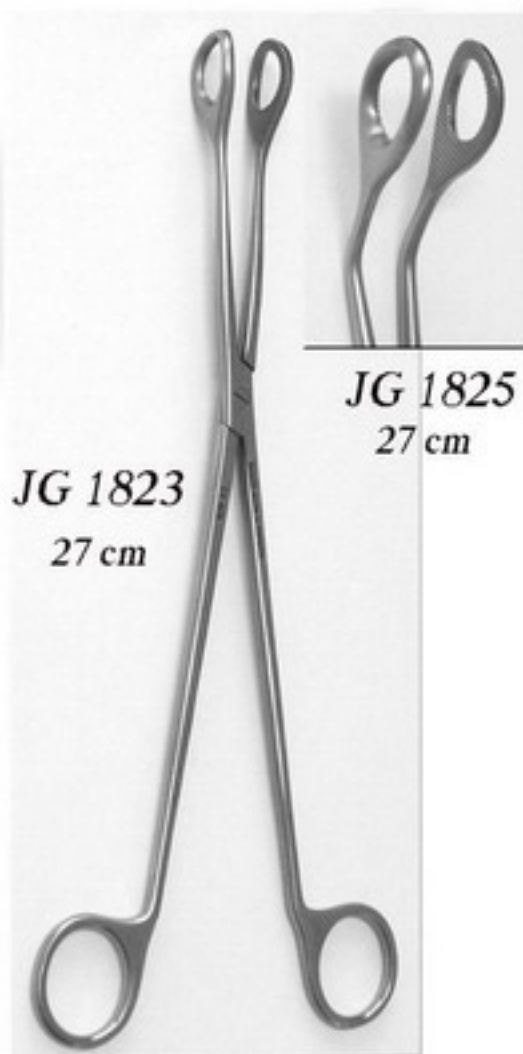

JG 1823
 27 cm

JG 1825
 27 cm

STERILIZÁLÓ-

MŰSZERKISZEDŐ FOGÓK
STERILISIERZANGE
STERILIZING FORCEPS

MŰSZERTÁROLÓ DOBOZ
INSTRUMENTEN BEHALTER
INTRUMENTS BOXES

	L	W	H
20-066-00	17	7	3
20-067-00	17.5	7.5	3
20-068-00	18	6	3
20-069-00	18	7	3
20-070-00	18	9	4
20-071-00	20	10	4
20-072-00	21	10	4

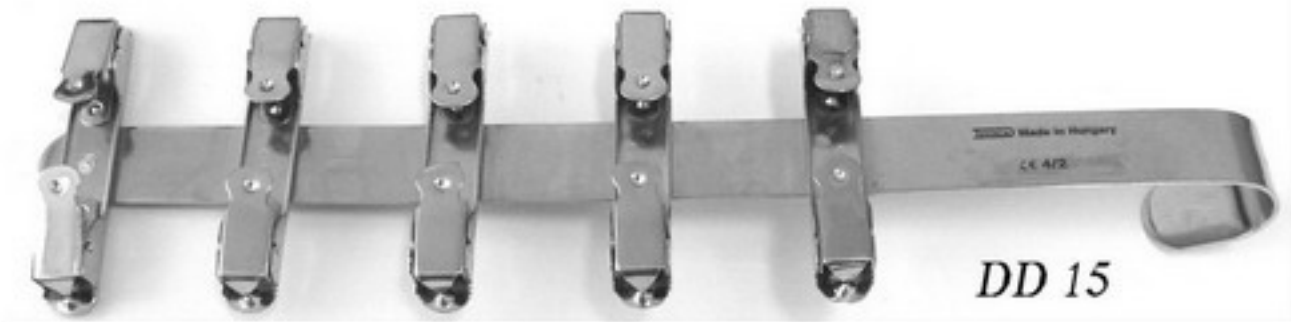
**DD 15**

RÖNTGENFILMLÉTRA
FILMLEISTE
X-RAY FILM HOLDER

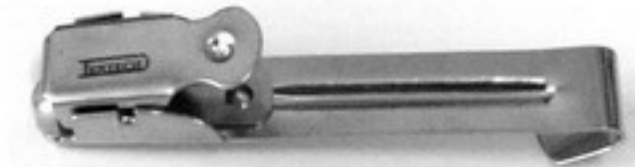
**DD 16**

RÖNTGENFILM CSIPESZ
RÖNTGENFILM PINZETTE
X-RAY FILM CLIP

**DD 17**

FOGFILM TARTÓ FERENCZI-FÉLE
ZAHNFILMHALTER FERENCZI
DENTAL FILM HOLDER FERENCZI

**DF 1750**

ASZTALI VATTATARTÓ, FÉM
WATTEBEHALTER, METALL
COTTON WOOL HOLDER

**DF 1751**

BORSZESZÉGŐ
SPIRITUSLAMPE
ALCOHOL BURNER

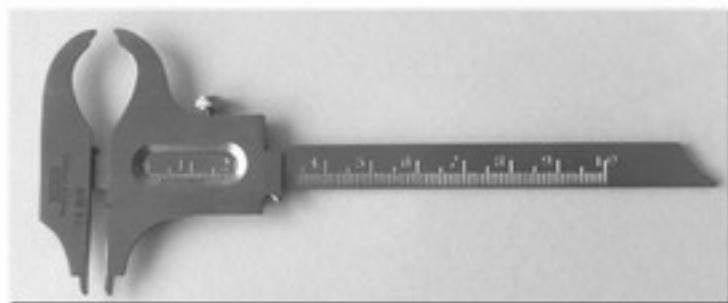

**MI 101**

BOLEY TOLÓMÉRŐS CSONTVASTAGSÁGMÉRŐ
BOLEY SCHIEBLEHRE
BOLEY BONE MEASURING INSTRUMENT

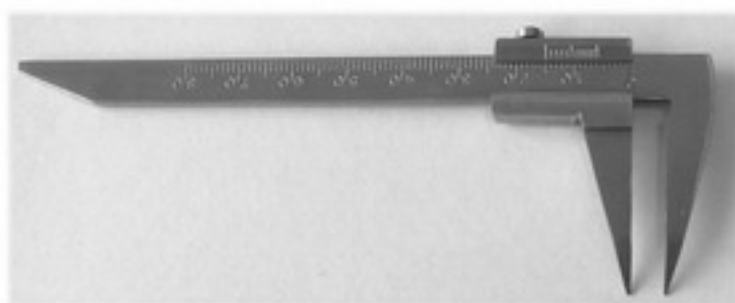
**MI 102**

BEERENDONK TOLÓMÉRŐS
CSONTVASTAGSÁGMÉRŐ
BEERENDONK SCHIEBLEHRE
BEERENDONK BONE MEASURING INSTRUMENT

**MI 103**

CSONTVASTAGSÁGMÉRŐ GYŰRŰS
KNOCHEN MEßZIRKEL
BONE MEASURING INSTRUMENT
 13 cm

**MI 104**

CASTROVIEJO CSONTVASTAGSÁGMÉRŐ
CASTROVIEJO KNOCHEN MEßZIRKEL
CASTROVIEJO BONE MEASURING INSTRUMENT
 9 cm

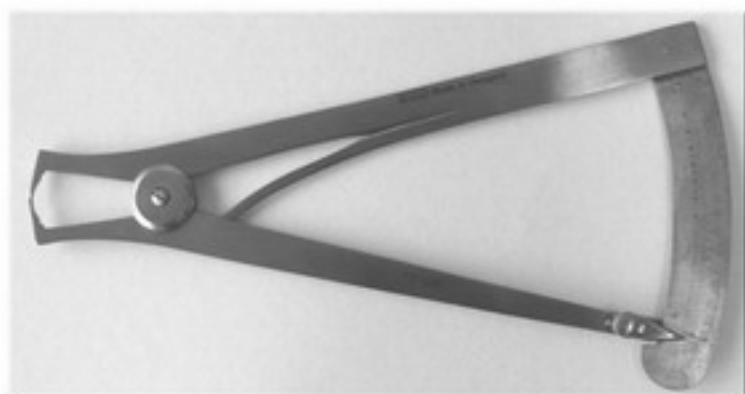
**MI 105**

CSONTVASTAGSÁGMÉRŐ GYŰRŰS
KNOCHEN MEßZIRKEL
BONE MEASURING INSTRUMENT

IMPLANTOLÓGIAI SZETT KI 100
 SET FÜR IMPLANTOLOGIE
 IMPLANTOLOGY SET

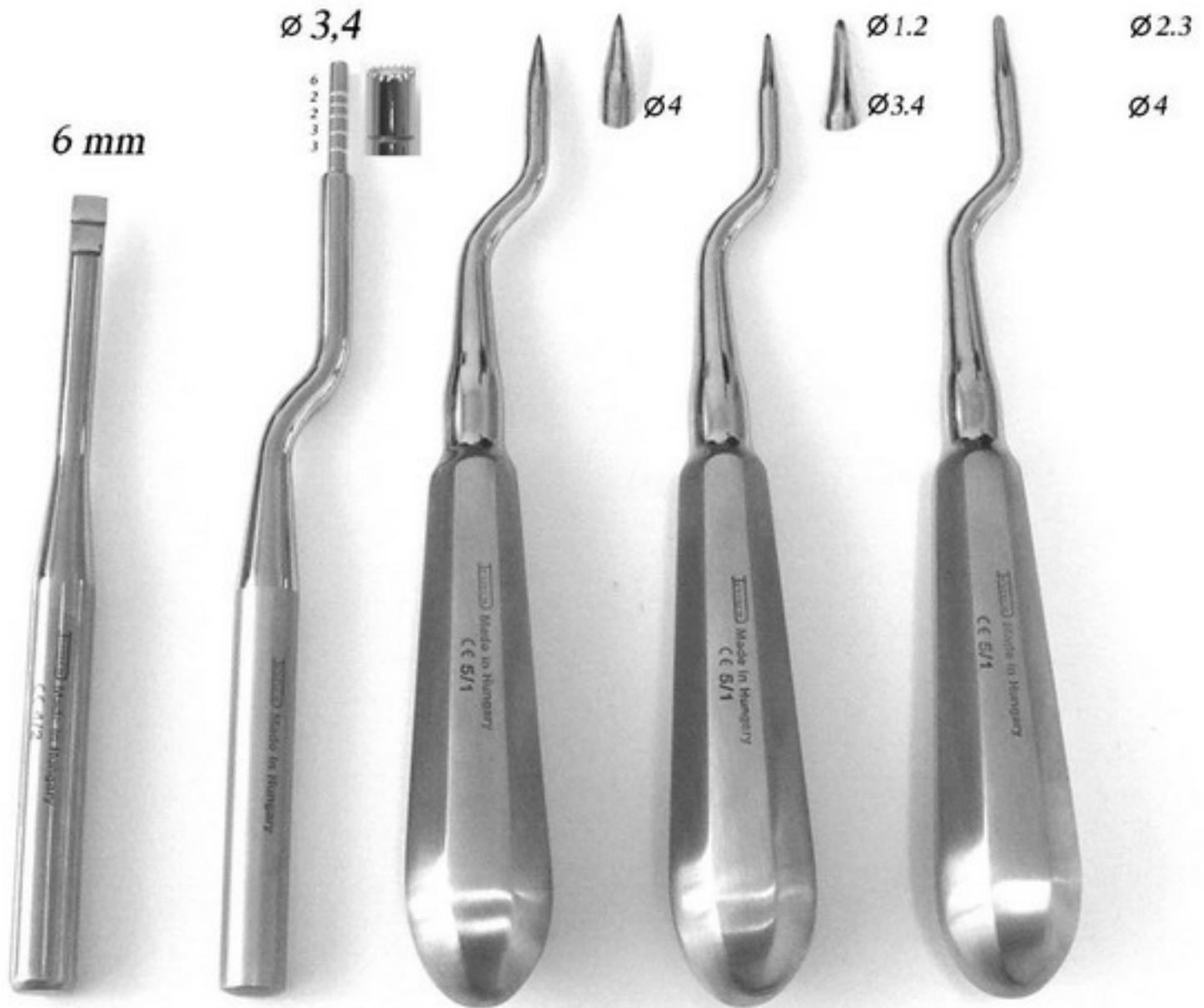

VI 101

BI 100

TI 100

TI 101

TI 102



TP 100
 TITÁN CSIPESZ
 TITAN PINZETTE
 TITAN FORCEPS
 14.5 cm



SINUS RASPATÓRIM
 SINUS RASPATORIUM
 SINUS RASPATORY

RI 100

56.



CSONTTÖMÖRÍTŐ CT
OSTEOTOM BAJONETT
OSTEOTOM BAYONET

6 mm
2 mm
2 mm
3 mm
3 mm



SINUSBEÜTŐ SB
SINUTOM BAJONETT
SINUTOME BAYONET

6 mm
2 mm
2 mm
3 mm
3 mm

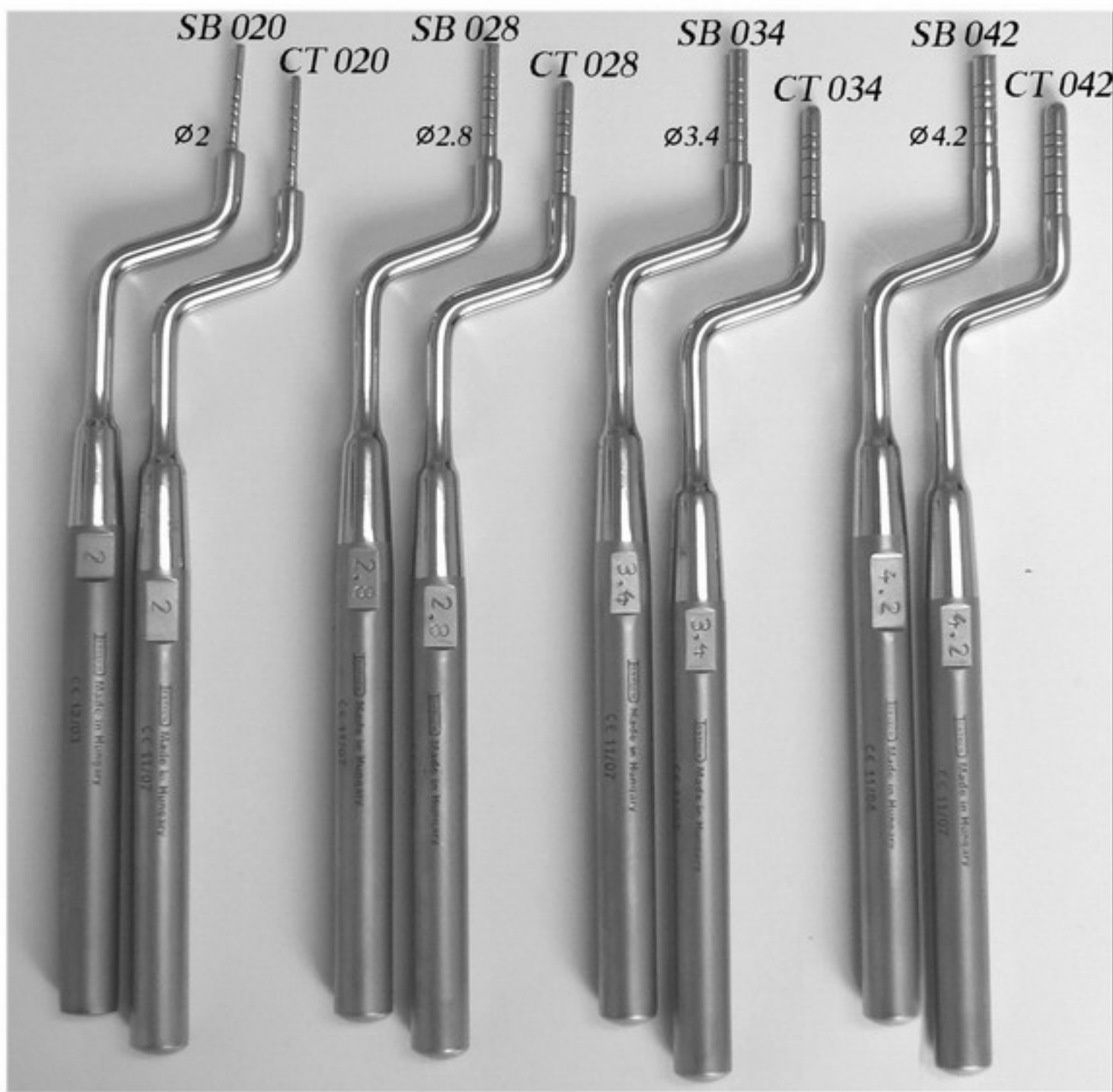

SB 020

CT 020

Ø2

SB 028

CT 028

Ø2.8

SB 034

CT 034

Ø3.4

SB 042

CT 042

Ø4.2



SINUS BEÜTŐ ÜTKÖZŐVEL
 SINUTOM MIT STOPPER
 SINUTOME WITH STOPPER

SB120 Ø2 MM
 SB128 Ø2,8 MM
 SB134 Ø3,4 MM
 SB142 Ø4,2 MM



OSTEOTOM ÜTKÖZŐVEL
 OSTEOTOM MIT STOPPER
 OSTEOTOME WITH STOPPER

CT120 Ø2 MM
 CT128 Ø2,8 MM
 CT134 Ø3,4,MM
 CT142 Ø4,2 MM



CD1000
CSONTDARÁLÓ
KNOCHENMÜHLE
BONE-MILL

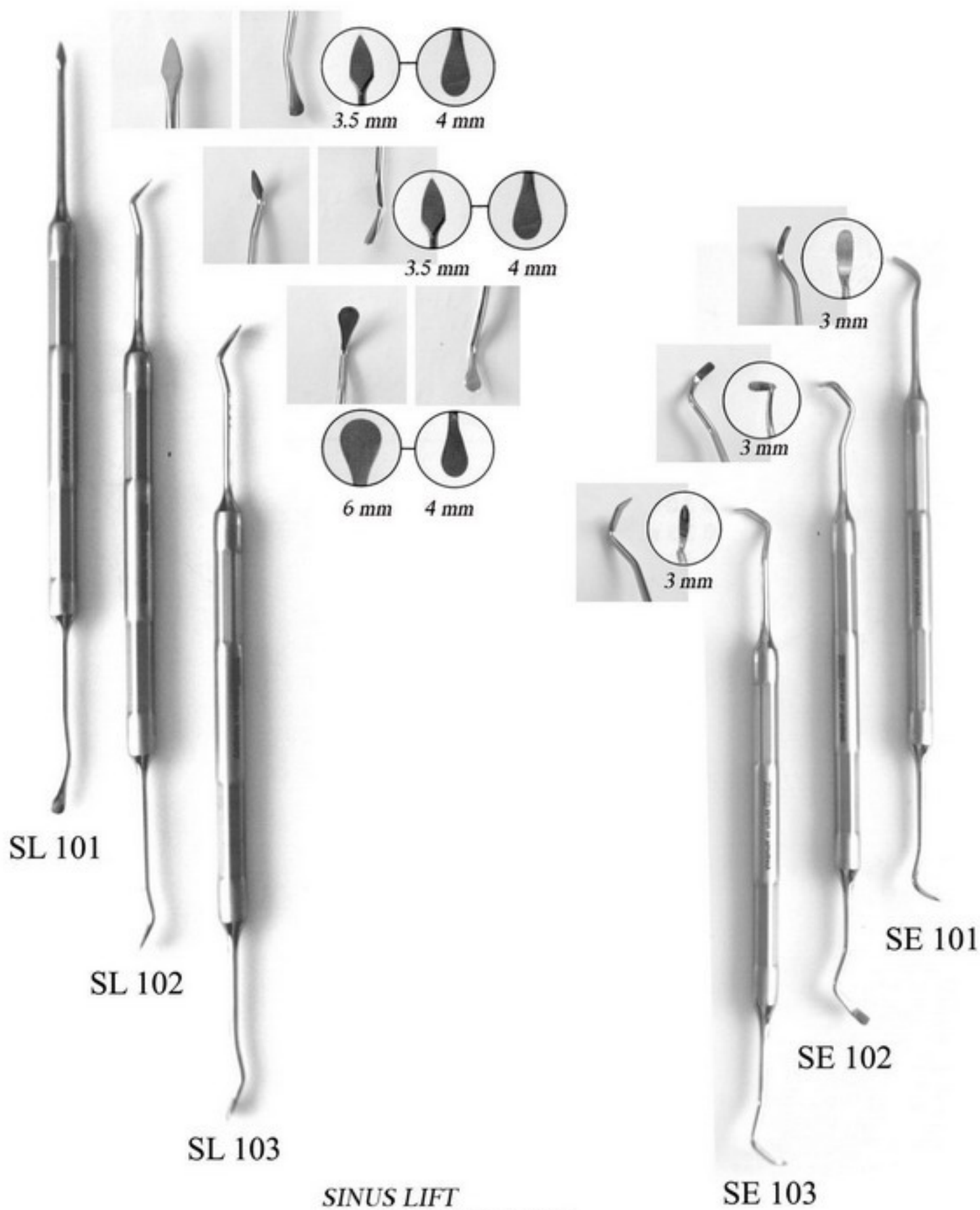

SINUS LIFT
SINUS LIFT INSTRUMENTE
SINUS LIFT INSTRUMENTS

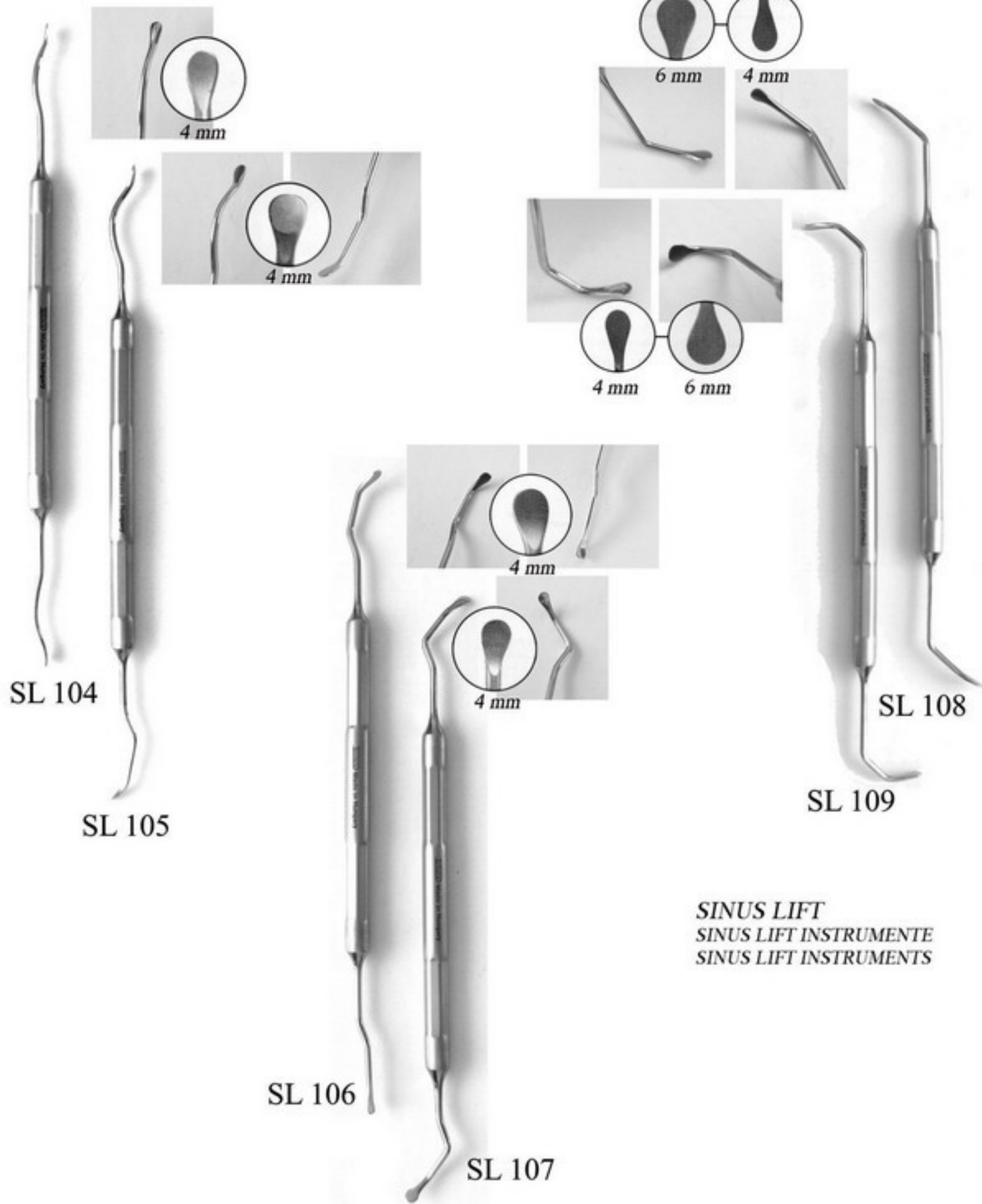

*SINUS LIFT
SINUS LIFT INSTRUMENTE
SINUS LIFT INSTRUMENTS*

CSONTCSÍPŐK - 14 cm

HOHLMEISSELZANGE -

BONE RONGUER FORCEPS





DP 2000
KOFFERDAMM FOGÓ
KOFFERDAMM ZANGE
CLAMP FORCEPS

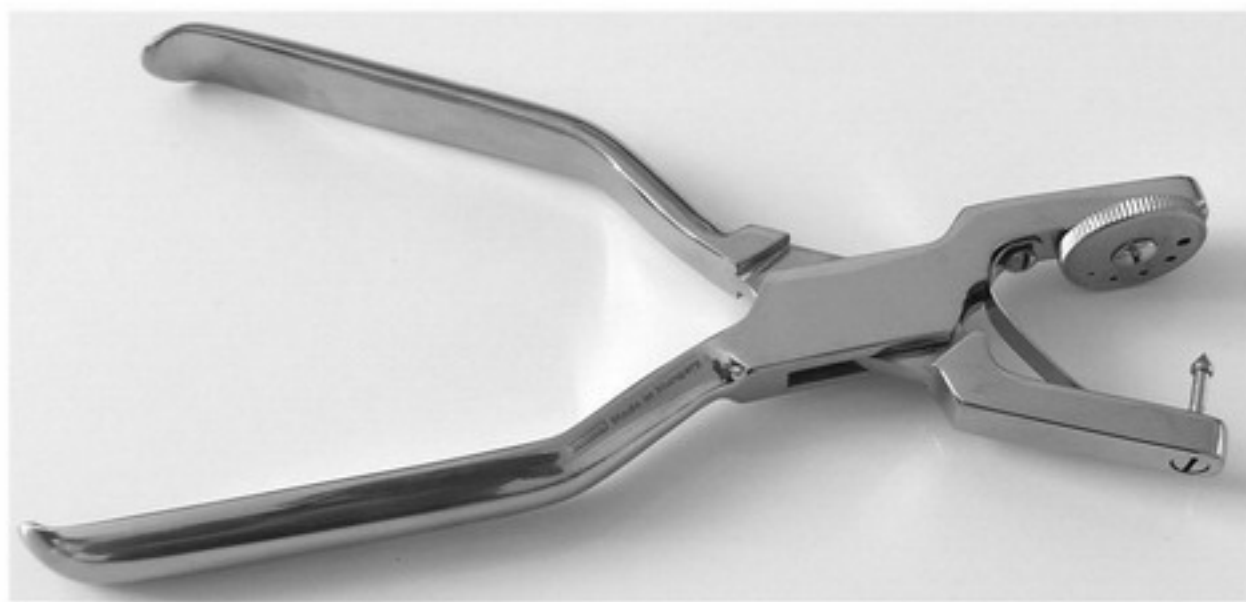

DP 2100
KOFFERDAMM LYUKASZTÓ
KOFFERDAMM LOCHZANGE
RUBBER DAM PUNCH

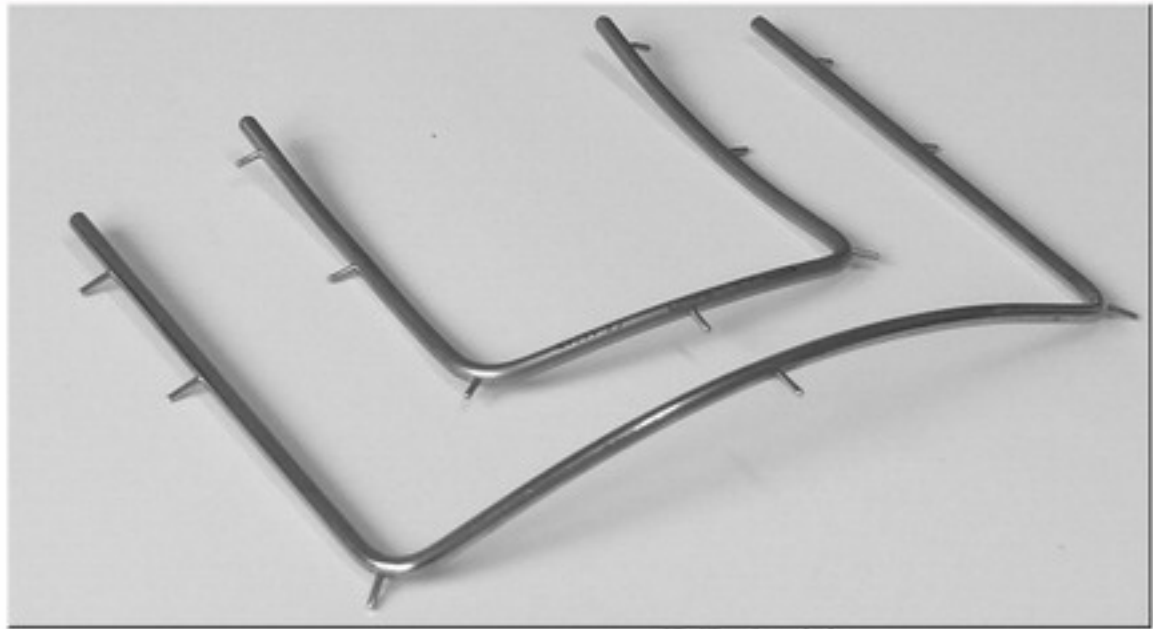

DR 2100
KOFFERDAMM KERET
KOFFERDAMM RAHMEN
RUBBERDAM FRAME

DK 2100
KOFFERDAMM KAPOCS
KOFFERDAMM KLAMMERN
RUBBERDAM CLAMP

212



FRONT-ANTERIOR

PREMOLÁRIS-PRAMOLAR-PREMOLAR

0



VÉKONY FOGHOZ
 MIT DÜNNEM ZAHNHALS
 FOR THIN THEETH

1



FELSŐ
 STANDARKLAMMER
 FÜR OBERE PRAMOLAREN
 STANDARDCLAMP FOR
 UPPER PREMOLARS

2



ALSÓ
 STANDARKLAMMER
 FÜR UNTERE PRAMOLAREN
 STANDARDCLAMP FOR
 LOWER PREMOLARS

27



ALSÓ-FELSŐ
 FÜR OBERE UND UNTERE
 PRAMOLAREN
 FOR UPPER AND LOWER
 PREMOLARS

MOLÁRIS-MOLAR-MOLARE

7



ALSÓ
 STANDARKLAMMER
 FÜR UNTERE MOLAREN
 STANDARDCLAMP
 FOR LOWER MOLARS

8



FELSŐ
 STANDARKLAMMER
 FÜR OBERE MOLAREN
 STANDARDCLAMP
 FOR UPPER MOLARS

8A



GYÖKÉR ALSÓ-FELSŐ
 WURZELKLAMMER FÜR OBERE
 UND UNTERE MOLAREN
 ROOTCLAMP FOR UPPER
 AND LOWER MOLARS

14A



FERDE FOGAKHOZ
 FÜR SCHRAGSTEHENDE
 MOLAREN
 FOR OBLIQUE THEETH

64.

INTENTECH



OD 200
GYŰRŰ FELNYOMÓ , LEVEVŐ
REINIGER
SCALER



OD 1756
GYŰRŰFELNYOMÓ
BANDAUFSETZER
BAND PUSHER



OD 202 17 cm
STOKE
SZEPARÁLÓ GUMIGYŰRŰ FELRAKÓ FOGÓ
SEPARIERZANGE ZUM SPREIZEN DER
DENTALASTIC-SEPARIERRINGE VOR DEM POSITIONIEREN
SEPARATING PLIERS FOR EXPANDING DENTALASTICS
BEFORE POSITIONING

TÚFOGÓK - NADELHALTER - NEEDLE HOLDERS
 KEMÉNYFÉM BETÉTES
 TC



ARRUGA
 16 cm



BM 1000 14 CM
 BACHMANN



OD 1000 BRACKET CSIPESZ
 BRACKET-PINZETTE
 BRACKET PLACING TWEEZERS



OD 1307
 BRACKET LEVEVŐ FOGÓ
 BRACKET-ABNEHME ZANGE
 BRACKET REMOVING PLIERS

KEMÉNYFÉM BETÉTES
TC



MAX 0,18 X 0,22 mm

OD 100 13 cm
DISZTÁL VÁGÓ KFB.
DISTAL-SCHNEIDER TC.
DISTAL CUTTER TC.

KEMÉNYFÉM BETÉTES
TC



MAX 0,7 mm

OD 101 13 cm
LIGATÚRVÁGÓ KFB.
LIGATURENSCHNEIDER TC.
LIGATURE CUTTING PLIERS TC.



14 cm

MAX 0,9 mm

MAX 1,2 mm

DP 1500

DRÓTVÁGÓ
DRAHTSCHNEIDEZANGEN
WIRE CUTTERS

LIGATURA FOGÓK
LIGATUREN ZANGE
LIGATURE FORCEPS



OD 201

LIGATURA ADAPTER
LIGATURENADAPTER
LIGATURE TUCKER



TC

OD 102



OD 103

WEINGART 14 cm



DP 1390

HOW 14 cm



DP 1393

HOW 14 cm

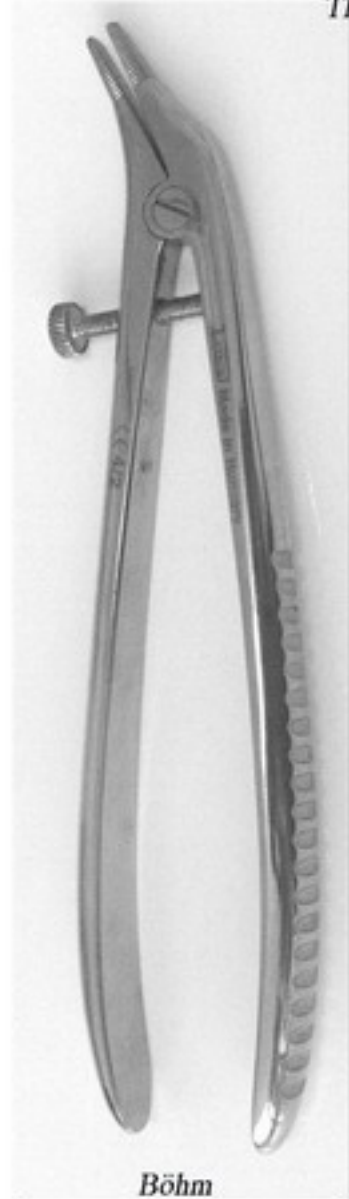
TELESZKÓP KORONAFOGÓ -
TELESKOP KRONEN ZANGE -
TELESCOPE CROW PLIERS
FOGTECHNIKAI FOGÓK
TECHNIK ZANGE
TECHNICAL PLIERS

Böhm
15 cm / 6"

MAX 0,9 mm

MAX 0,7 mm



MAX 1 mm

Waldsachs

DP 1360 15 cm
DP 1505 15 cm
**UNIVERZÁLIS
KRAMPONFOGÓ**
UNIVERSAL-KRAMPONZANGE
UNIVERSAL TECHNICAL PLIERS

BÖHM	a	b	c	d
DP 1739	3,3	4,0	2,3	3,0mm
DP 1740	4,4	5,0	3,4	3,8mm

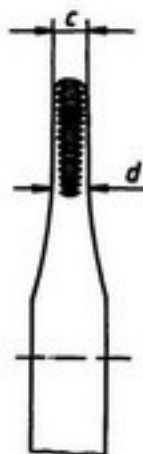
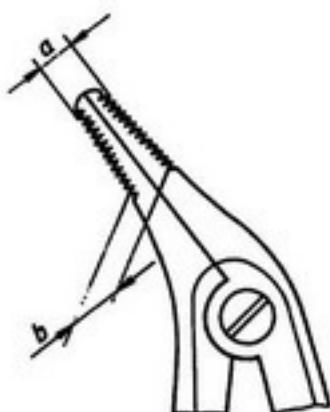

MAX 0,9 mm

MAX 0,7 mm

**KRAMPONFOGÓ
KARAMPON ZANGE
UNIVERSAL
TECHNICAL PLIERS**
DP 1501 15 cm

DRÓTHAJLÍTÓ FOGÓK MAX 0.7 mm
DRAHTBIEGEZANGEN
WIRE BENDING PLIERS



DP 1122 14 cm
LANGENBECK



DP 1315 13 cm
ADERER



DP 1316 13 cm
ADERER



DP 1312 13 cm
ADAMS

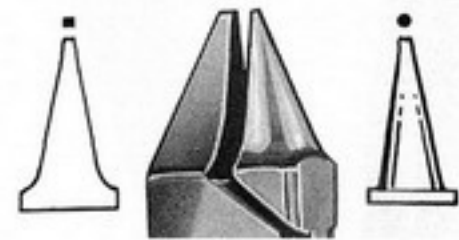

DP 1310 13 cm
ANGLE

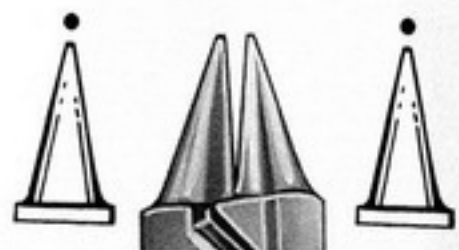

DP 1311 13 cm
ANGLE

LAPOS FOGÓK - FLACHZANGEN - FLAT NOSE PLIERS

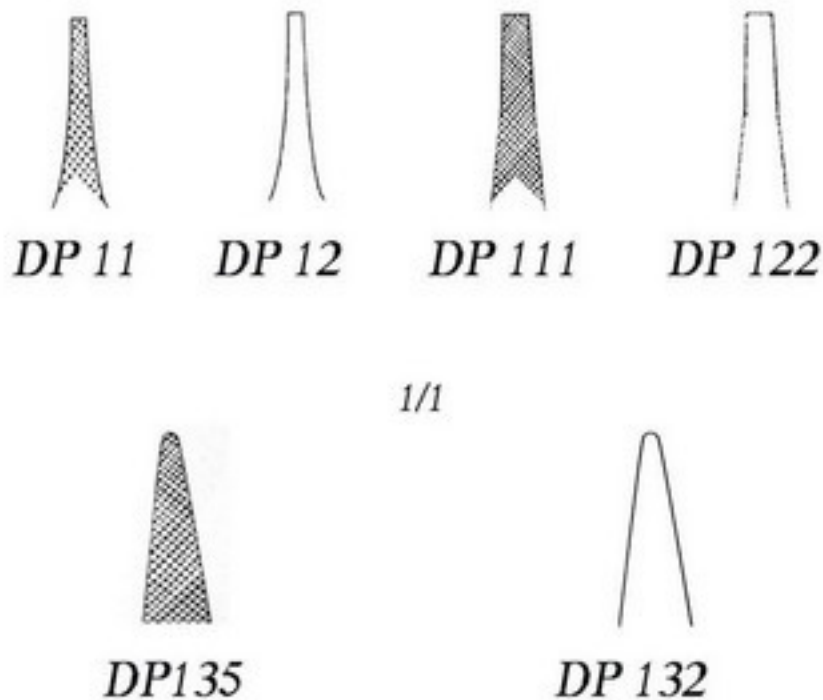

ÍVHAJLÍTÓ FOGÓK - DRAHTBIEGEZANGEN - WIRE BENDING PLIERS



max 1,5 mm



DRÓTHAJLÍTÓ FOGÓK

DRAHTBIEGEZANGEN

WIRE BENDING PLIERS

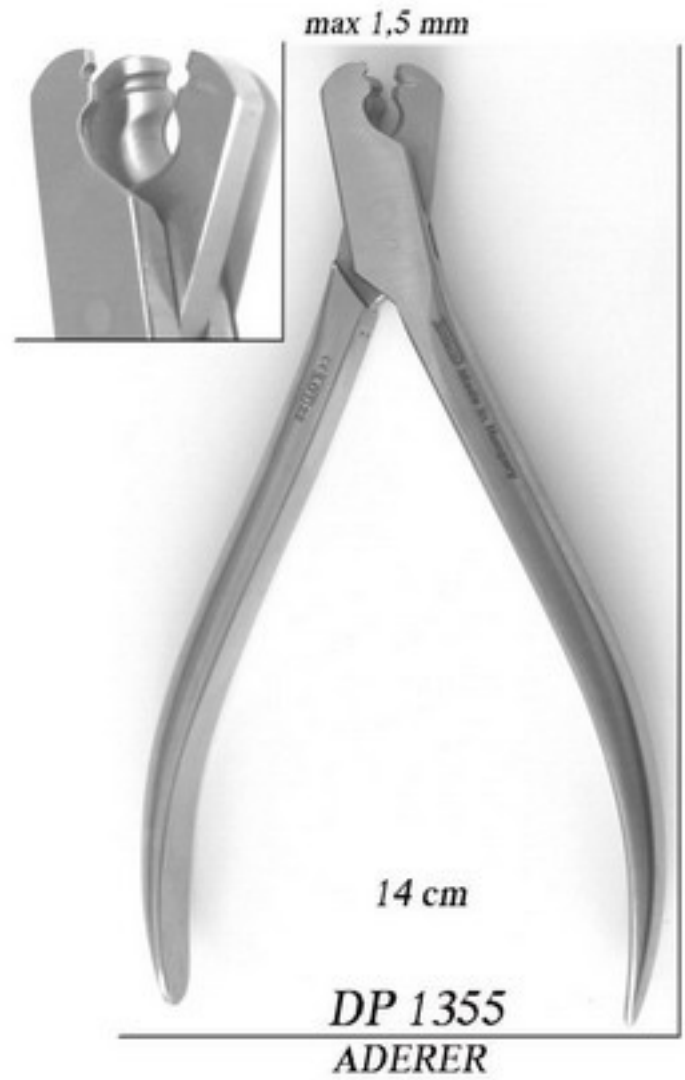



14 cm

OD 1327

NANCE

LÉPCSŐS HAJLÍTÓ FOGÓ

SCHLAUFENBIEGEZANGE

LOOP FORMING PLIERS

ÍVFORMÁZÓ FOGÓ
BOGENFORMZANGEN
ARCH FORMING PLIERS



13 cm

OD 1317

TWEED

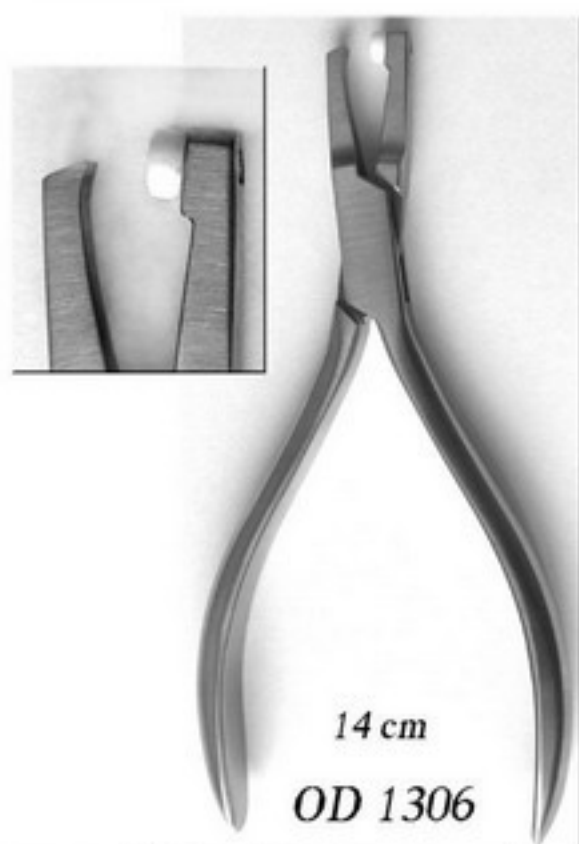

14 cm

OD 1306

GYÚRÚ LEVEVŐ FOGÓ TEFLON BETÉTTTEL
BAND-ABNEHME ZANGE MIT TEFLON EINZATZ
BAND REMOVING PLIERS WITH TEFLON INSERT

max 1,0 mm

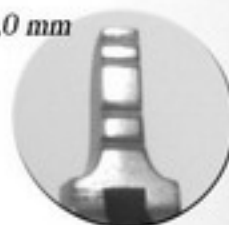

max 0,7 mm



14 cm

OD 1337

KENGYELHAJLÍTÓ FOGÓ
BÜGELBIEGEZANGE
LINGUAL ARCH BENDING PLIERS

FOGTECHNIKAI MINTÁZÓ -

MODELLIER INSTRUMENTE

MODELLING INSTRUMENTS

DS 1301



DS 1302

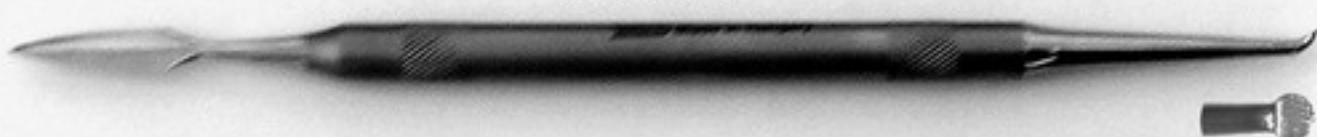

DS 1303

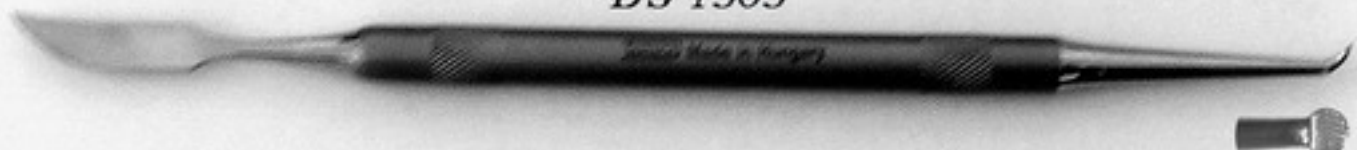

DS1304



DS 1305



DS 1306



DS 1307



FOGTECHNIKAI MINTÁZÓ -

MODELLIER INSTRUMENTE

MODELLING INSTRUMENTS

DS 1308

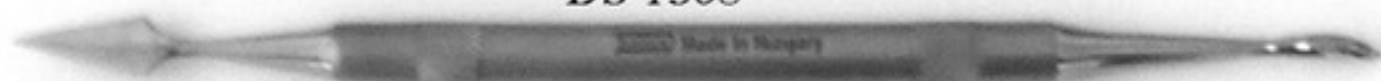

DS 1309

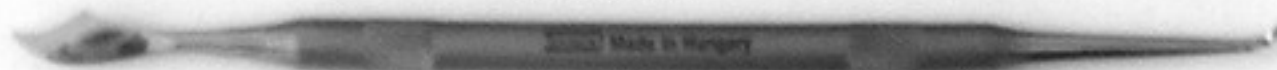

DS 1310



DS 1311



DS 1312

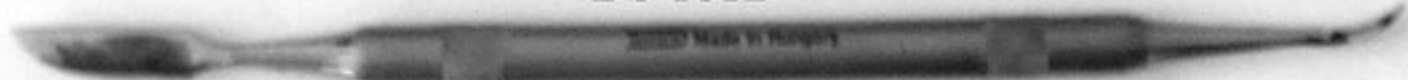

DS 1313

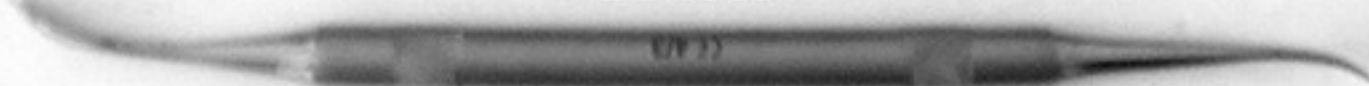

DS 1314

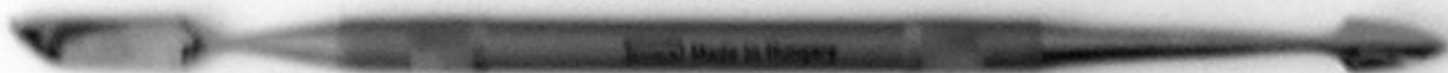

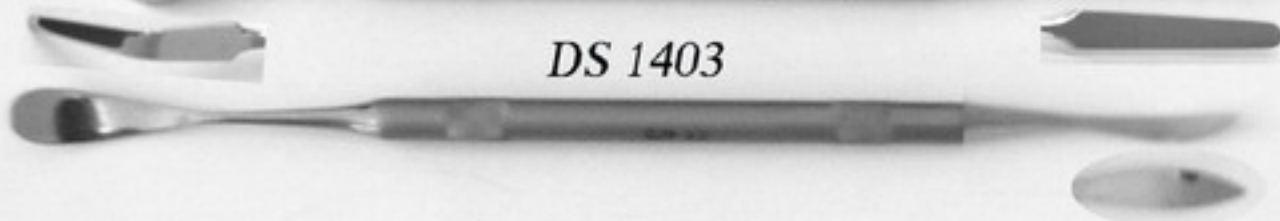
AKRILÁT FELRAKÓ - AKRYLATE INSTRUMENTE - ACRYLATE MODELLING INSTRUMENTS**DS 1401****DS 1402****DS 1403**

P. K. THOMAS FELRAKÓK
MODELLIERINSTRUMENTE
P. K. THOMAS INSTRUMENTS

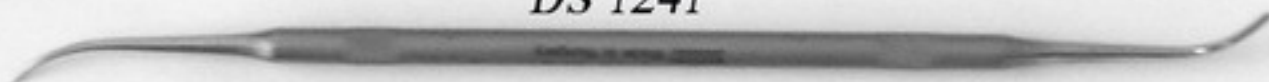
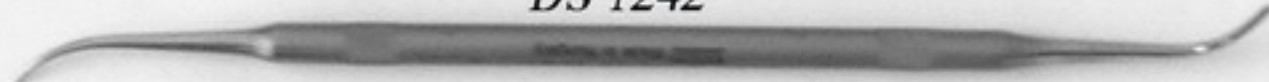
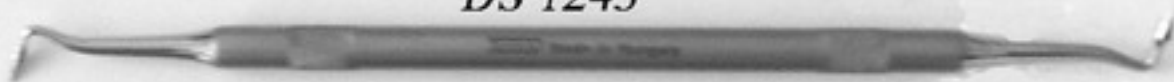
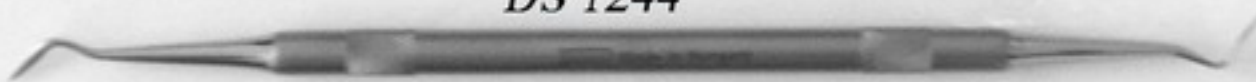
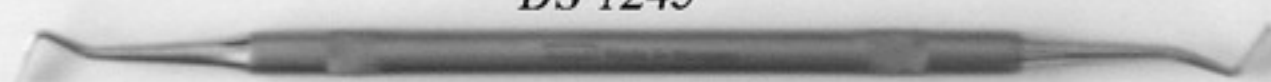
DS 1241**DS 1242****DS 1243****DS 1244****DS 1245****GRAVÍROZÓ - GRAVIERER - ENGRAVER****DS 1405****DS 1404**

KERÁMIASZEPARÁLÓ KÉS
SEPARIERMESSER AUS KERAMIK
SEPARATE KNIFE FOR CERAMICS

DS 100

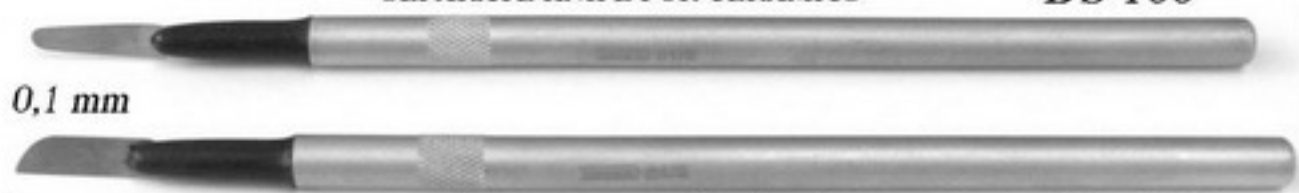

0,1 mm

KERÁMIASZEPARÁLÓ KÉS
SEPARIERMESSER AUS KERAMIK
SEPARATE KNIFE FOR CERAMICS

DS 101



PATRONOS BEFOGÓ
PATRONENSPANNER
CARTRIDGE CLAMP

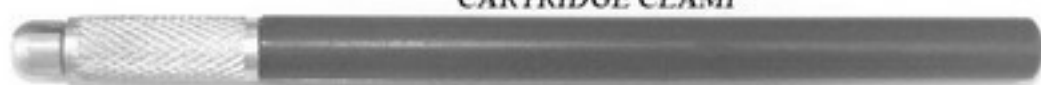

DS 1353

DS 1350



TIPUS/TYP/TYPE FIG.11
GRAVÍROZÓ BETÉTHEGY
EINSATZSPITZ FÜR
GRAVIERINSTRUMENTE
TIP FOR CATRIDGE CLAMP



DS 103



DS 102

KORONAFOGÓ KERÁMIA FELRAKÁSÁHOZ
KRONENHALTEKLEMMEN
CROWN HOLDING CLAMPS

GIPSZLAPOC
GIPSSPATELN
PLASTER SPATULAS

ALGINATE ÉS GIPSZSPATULÁK
SPATELN FÜR ALGINAT UND GIPS
ALGINAT AND PLASTER SPATULAS



DS 115 DS 118



Lichtenstein

DS 120

GIPSZKÉSEK
GIPSMESSER
PLASTER KNIFE

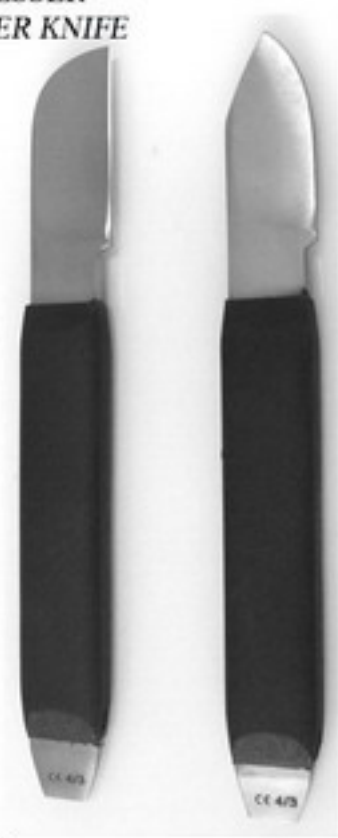

DS 160 DS 161

VIASZKÉSEK
WACHSMESSER
WAX KNIVES

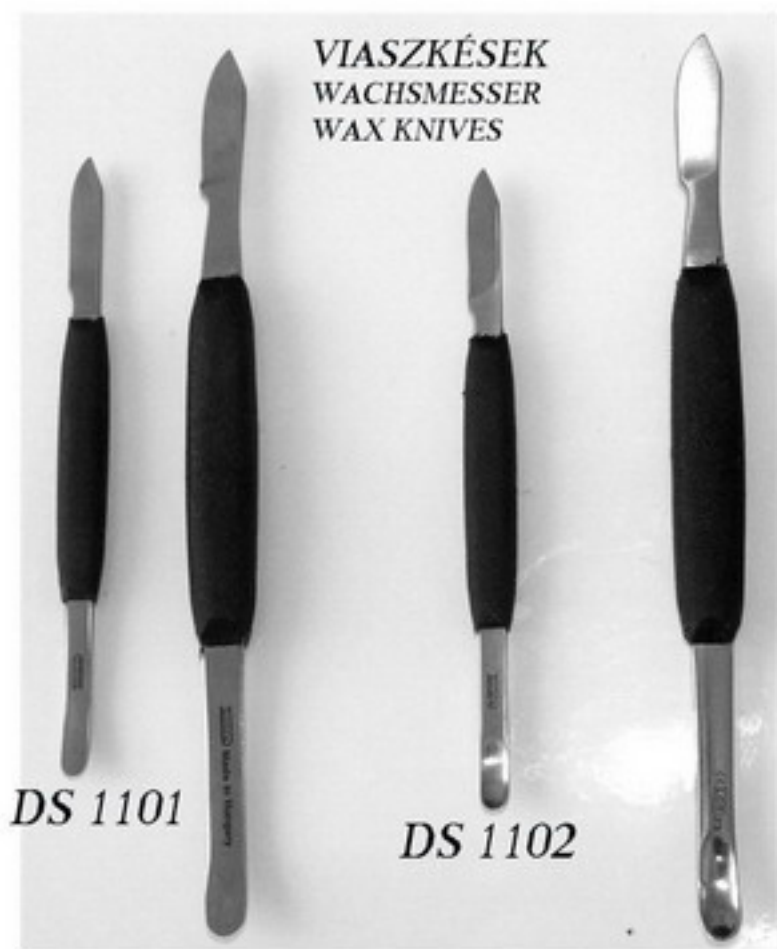

DS 1101

DS 1102

DS 1103

DS 1104

78.

TENTECH



GIPSZ OLLÓ
GIPSSCHERE
PLASTER CUTTING FORCEPS



DU 153

ADAPTA FOGÓ
ADAPTA ZANGE
FOIL HOLDER

KÜVETTA KENGYEL
KÜVETTENBÜGEL
FLASK CLAMP

DS 1706

DS 1705

DS 1704

Stainless

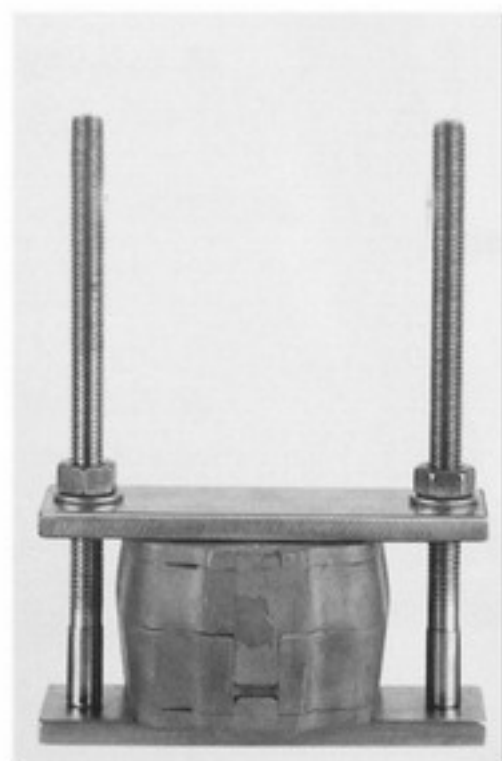

ÖNTÖGYŰRŰ FOGÓ
TIEGEL ZANGE
MOULD TONGS



DS 2400
40 cm

DS 2401
60 cm

80.

TENTECH

ÖNTÖGYŰRŰ - MUFFELRINGE - CASTING RINGS



DU 151

TECHNIKAI KALAPÁCS
HAMMER FÜR ZAHNTECHNIK
TECHNICAL MALLETS



Ø30 x 2 x 55

DS 2501

Ø48.3 x 2 x 55

DS 2503

Ø63.5 x 2 x 55

DS 2506



Ø80 x 2 x 55

DS 2509



DS 2500

BEÁGYAZÓ GUMITALP
MUFFEL BÖDEN
MOULD BASE SOCKET



DS 2780
FORRASZTÓ CSIPESZEK
LÖTPINZETTEN
SOLDERING TWEEZERS



DS 2781



DS 2405

KORONA FALVASTAGSÁG MÉRŐ IWANSON
MESSZIRKEL IWANSON
CALIPER IWANSON



100 x 80 x 60
ALUMINIUM

DS 2404



95 x 70 x 50
ALUMINIUM

DS 3404

DUBLIR KÜVETTA
DUBLIR KÜVETTE
DUPLICATING FLASK

KORONA OLLÓK - KRONENSCHERE - CROWN SCISSORS



DP 1561



DP 1562



DP 1563



DP 1560
BEEBEE
11 CM

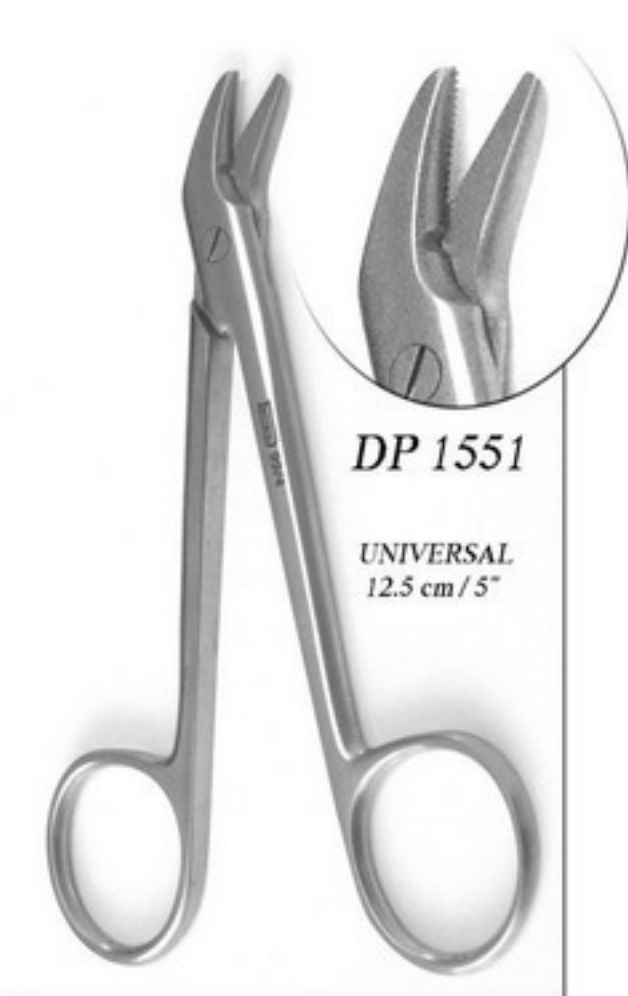

DP 1551

UNIVERSAL
12.5 cm / 5"



Stainless

**LENYOMATKANÁL, FÉM
ABDRUCKLÖFFEL AUS METALL
IMPRESSION TRAY
STAINLESS STEEL**



Stainless



Stainless

Number	Size	mm.	mm.
29-075-U5A	XL	76	63
29-076-U5A	L	74	62
29-077-U4A	M	71	58
29-078-U3A	S	68	54
29-079-U2A	XS	66	51
29-080-U1A	XXS	63	48

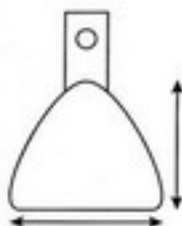

Number	Size	mm.	mm.
29-081-L6	XL	78	59
29-082-L5	L	77	56
29-083-L4	M	76	57
29-084-L3	S	72	52
29-085-L2	XS	59	50
29-086-L1	XXS	56	48

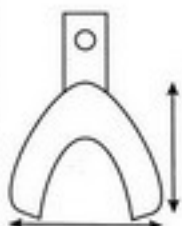

Number	Size	mm.	mm.
29-087-U1	XXS	63	48
29-088-U2	XS	66	51
29-089-U3	S	68	54
29-090-U4	M	71	58
29-091-U5	L	74	62
29-092-U6	XL	76	63

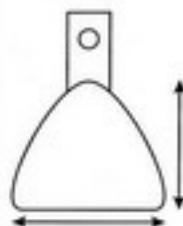

Number	Size	mm.	mm.
29-093-L1	XXS	56	48
29-094-L2	XS	59	50
29-095-L3	S	72	52
29-096-L4	M	76	57
29-097-L5	L	77	56
29-098-L6	XL	78	59

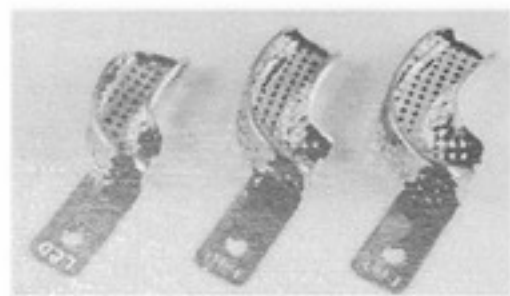
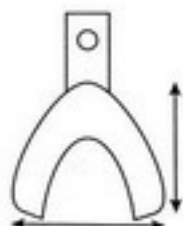

Number	Size
29-099-L6D	L
29-100-L4D	M
29-101-L2D	S

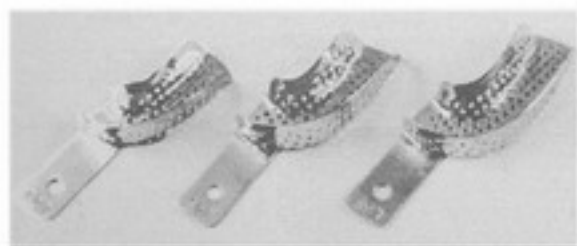

Number	Size
29-102-L6S	L
29-103-L4S	M
29-104-L2S	S



Number	Size	mm.	mm.
29-125-U61	L	79	70
29-126-U62	M	76	67
29-127-U63	NM	70	64
29-128-U64	S	73	60

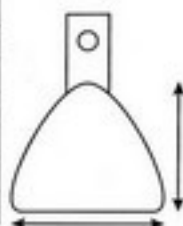

Number	Size	mm.	mm.
29-129-L66	L	86	64
29-130-L67	NL	70	64
29-131-L68	M	73	60
29-132-L69	S	70	57

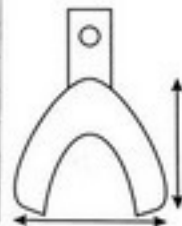

CEMENTKEVERŐ ÜVEGLAP - ZEMENT MISCHPLATTE AUS GLAS -
CEMENT MIXER PLATE GLASS



DF 1120
100 X 100



DF 1121
130 X 80



DD 14
40 cm

SZALVÉTATARTÓ
SERVIETTENHALTER
NAPKIN HOLDER



DL 101
LENYOMATVÁGÓ
ABDRUCKSCHNEIDER
IMPRESSION CUTTER

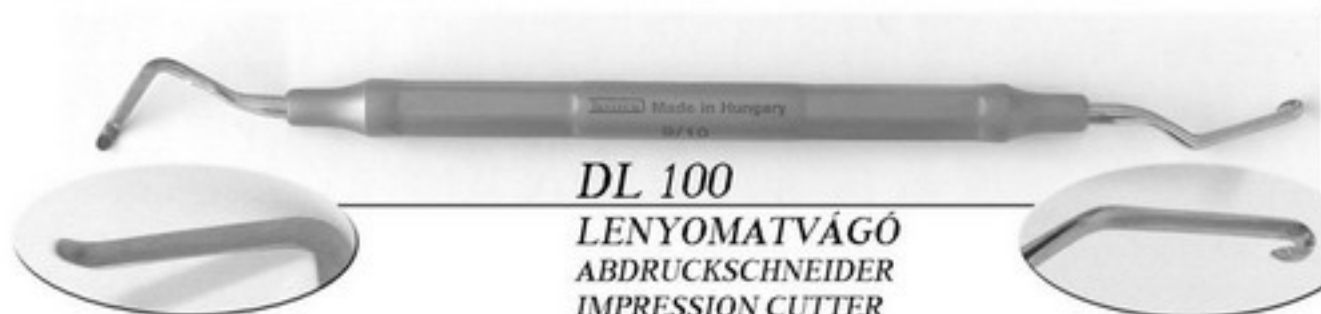
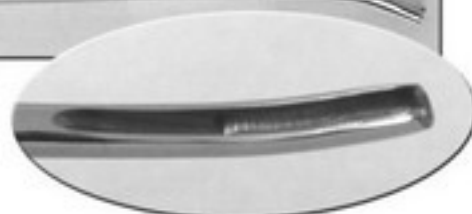

DL 100
LENYOMATVÁGÓ
ABDRUCKSCHNEIDER
IMPRESSION CUTTER



SZÁJSEBÉSZETI NYÁLSZÍVÓ, FÉM
SPEICHELSAUGER FÜR STOMATOLOGIE, METALL
SUCTION TUBE FOR STOMATOLOGY, STAINLESS STEEL



DD 12
NYÁLSZÍVÓPIPA, FÉM
SAUGENKANÜLE, METALL
SUCTION TUBE



DZ 852
18 x 14 x 2.5 cm

MÚSZERDOBOZ 10 DB-OS
INSTRUMENTEN BEHALTER
FÜR 10 STK.
INTRUMENTS BOXES FOR 10 PCS

DZ 853
28 x 18 x 3 cm

MÚSZERDOBOZ 20 DB-OS
INSTRUMENTEN BEHALTER
FÜR 20 STK.
INTRUMENTS BOXES FOR 20 PCS



DZ 851
18 X 7 X 2.5 cm

MÚSZERDOBOZ 5 DB-OS
INSTRUMENTEN BEHALTER
FÜR 5 STK.
INTRUMENTS BOXES FOR 5 PCS